

TITAN IMPLEMENT

1700 1800 Series Rotary Cutters

OPERATION AND PARTS MANUAL

Read and understand the manual. This manual provides information and procedures to safely operate and maintain the Rotary Cutter.



Serial Number 0010001 and Up

Pre-Delivery Checklist

The Dealer should inform the Purchaser of this product of the Warranty terms, provisions, and procedures that are applicable. The Dealer and Purchaser should review the contents of the Operator's Manual including safety equipment, safe operation and maintenance, review the Safety Signs on the implement (and tractor if necessary), and the Purchaser's responsibility to train their operators in safe operation procedures.

- **IMPLEMENTS:** I have explained that Deflectors, Guards, or Shields must be installed and maintained in good repair.
- **DRIVELINES:** I have made certain that all driveline, gearbox, and other shields are in good repair and fastened securely in place to prevent injuries from entanglement or thrown objects.
- **MOUNTED IMPLEMENTS:** I have explained that it is not possible to guard against thrown objects when the cutter is lifted off the ground, and that operator is responsible for watching out for persons in the work area.

PRE-DELIVERY SERVICE CHECK AND ADJUST OR LUBRICATE AS REQUIRED

See Operator's Manual for Details

Inspection Performed - Warranty and Safety Procedures Explained - Installation Complete

LUBRICATION & HYDRAULICS

- Gearbox Lubricant Level, Factory Filled

CUTTER

- Check that Gearbox Bolts are Properly Tightened
- Check that Blade Carrier Bolt is Properly Tightened and Cotter Pin is in Place
- Review Procedure to Adjust Cutting Height and Level
- Check that All Hardware is Properly Tightened
- Grease All Zerks

ATTACHMENTS & INSTALLATION

- Make Sure The Chain Shielding (Optional) is Attached
- Check that Blades are Installed in Correct Rotation Direction
- Make Sure All Bolts, Pins, and Nuts are Properly Installed and Tightened

CUTTER TO TRACTOR CONNECTIONS

- Make Sure A-Frame Pivot & Links are Properly Installed
- Make Sure Lift Arms are Adjusted Equal
- Pre-Operation Check Complete

SAFETY ITEMS

- Make Sure Protective Shields are Properly Installed
- Make Sure Safety Decals are Installed
- Review Operator's Manual (Supplied)
- Make Sure Tractor PTO Shield is Installed
- Make Sure S.M.V. Sign is Installed if Needed (Customer Supplied)
- ADMA Driveline Safety Manual Supplied
- AEM Mower Safety Manual (Supplied in Canister)
- AEM Mower Safety Video has Been Shown to Purchaser

I have thoroughly instructed the buyer on the above-described equipment. This review included the Operation and Parts Manual content, equipment care, adjustments, safe operation, and applicable warranty policy.

Date _____

Dealer Rep. Signature _____

The above equipment and Operator's Manual have been received by me, and I have been thoroughly instructed as to care, adjustments, safe operation, and applicable warranty policy.

Date _____

Owner's Signature _____

Titan Implement Will Provide

One (1) AEM Mower Safety Practices Video

Please Send Me: VHS Format – AEM/FEMA Mower Operator Safety Video
 DVD Format – AEM/FEMA Mower Operator Safety Video
 Operation and Parts Manual
 AEM Mower Operator's Safety Manual

Requester Name: _____ Phone: _____

Requester Address: _____

City: _____ State: _____

Zip Code: _____

Cutter Model: _____ Serial Number: _____

Date Purchased: _____ Dealer Salesperson: _____

Dealership Name: _____ Dealership Location: _____

Mail to:

Titan Implement
P.O. Box 649
Decatur, TN 37322

Or Fax to:

(423) 334-0023

Or E-mail to:

info@titanimplement.com

Cut Here to Remove Page or Make Copies of This Page

Table of Contents

1. INTRODUCTION	8	6.3 Attaching to Tractor	31
1.1 Welcome	8	6.4 Detaching from Tractor	31
1.2 Safe Operation	8	6.5 Setting the Rotary Cutter	32
1.3 Safety Shields	8	6.5.1 Setting the Cutting Height	32
1.4 Intended Usage	9	6.6 Tire and Wheel	32
1.5 Operator Orientation	9	6.7 Initial Setup Checklist	33
1.6 Serial Number Location (Typical)	9	6.8 Machine Break-In	34
1.7 Product Improvements	9	6.9 Pre-Operation Checklist	34
1.8 Disposal of Equipment at End of Useful Life	9	6.10 Operation Checklist	34
1.9 Unanswered Questions	9	6.11 Operating Safety	35
2. SAFETY	10	6.12 Optional Chain Shielding	36
2.1 General	10	6.13 Right of Way (Roadway) Mowing	36
2.2 Safety Alert Symbols	10	7. TRANSPORTING	37
2.3 Safety Icon Nomenclature	11	7.1 Transporting Safety (Road)	37
2.3.1 Personal Protection/Important Information	11	8. STORAGE	38
2.3.2 Prohibited Actions	11	8.1 Storage Safety	38
2.3.3 Hazard Avoidance	11	8.2 Placing In Storage	38
2.4 General Safety Instruction	12	8.3 Removing From Storage	38
2.5 Training	13	9. SERVICE AND MAINTENANCE	39
2.6 OSHA Training Requirements	13	9.1 Maintenance Safety	39
2.7 Federal Laws and Regulations	14	9.2 Greasing	40
2.8 Sign-Off Form	15	9.3 Gearbox Lubrication	40
2.9 Operation	16	9.4 Driveline Lubrication	40
2.10 Transporting	16	9.5 Blade Servicing	40
2.11 Storage	16	9.5.1 Blade Removal	40
2.12 Maintenance	16	9.5.2 Blade Installation	40
3. SAFETY SIGNS AND INSTRUCTIONAL LABELS	17	9.5.3 Blade Sharpening	41
3.1 General Information	17	9.6 Blade Carrier Removal	41
3.2 How to Install Replacement Safety Signs	17	9.7 Blade Carrier Installation	41
3.3 Safety Signs	18	9.8 Slip Clutch Operational Check	41
3.3.1 Cutter Deck Safety Signs	19	9.9 Slip Clutch Adjustment	42
4. NOMENCLATURE	21	9.10 Bolt Torque Requirements	42
4.1 Description and Intended Use	21	9.11 Welding Repairs	42
4.1.1 Owner/Operator Manual Storage	21	9.12 Service Record	43
4.2 Nomenclature	22	10. TROUBLESHOOTING	44
5. ASSEMBLY	23	11. SPECIFICATIONS	46
5.1 Tools Required	23	11.1 Bolt Torque	47
5.2 Assembly Procedure	23	11.1.1 Standard Torque Values	47
5.3 Installation and Removal of Driveline to Tractor PTO	27	12. WARRANTY	48
5.4 Checking the Driveline Length	27	13. PARTS	51
5.5 Shortening the Driveline	27	13.1 Hitch Assembly	51
6. OPERATION	29	13.2 Deck Assembly	52
6.1 User Safety Training	29	13.3 Tailwheel Assembly	53
6.2 Tractor Requirements	29	13.4 Driveline Assembly	54
6.2.1 Tractor Requirements and Capabilities	29	13.5 Driveline Detail	55
6.2.2 Tractor Safety Devices	30	13.6 Cutter Drive System	56
6.2.3 ROPS and Seat Belt	30	13.7 Center Tee Gearbox Detail	57
6.2.4 3-Point Hitch	30	13.8 Outboard Gearbox Detail	58
6.2.5 Tractor Horsepower	30	13.9 Blade Assembly	59
6.2.6 Power Take-Off (PTO)	30	13.10 Optional Chain Guard	60

1. INTRODUCTION

1.1 Welcome



1800 Series Rotary Cutter

Congratulations on your choice of a Titan Implement rotary cutter. This equipment has been designed and manufactured to meet the needs of discerning users. The Titan Implement rotary cutter is designed to cut grass, weeds, and light brush.

Many features incorporated into this rotary cutter are the result of suggestions made by customers like you. Read this manual carefully to learn how to operate the rotary cutter safely and how to set it to provide maximum cutting efficiency.

By following the operating instructions in conjunction with a good maintenance program, your Titan Implement rotary cutter will provide many years of trouble-free service.

This manual covers Titan Implement rotary cutter models:		
Model	Model	Model
1708	1808	1810

1.2 Safe Operation

Safe, efficient, and trouble-free operation of your rotary cutter requires that you, and anyone else who will be using or maintaining the unit, read and understand the information contained within the Owner's Manual.

Use this manual for frequent reference and to pass on to new operators or owners.

WARNING



Read And Understand Manual

To prevent personal injury or even death, be sure you read and understand all of the instructions in this manual and other related OEM equipment manuals! The rotary cutter, if not used and maintained properly, can be dangerous to users unfamiliar with its operation. Do not allow operating, maintaining, adjusting, or cleaning of this rotary cutter until the user has read this manual and has developed a thorough understanding of the safety precautions and functions of the unit.

This rotary cutter is designed for the specific purpose of cutting grass, weeds, and light brush. DO NOT modify or use this rotary cutter for any application other than that for which it was designed.

Rotary cutters maintained or operated improperly or by untrained personnel can be dangerous; exposing the user and/or bystanders to possible serious injury or death.

1.3 Safety Shields

Some of the illustrations in this manual may show the equipment with safety shields removed for clarity. Never operate the rotary cutter unless all safety shields are in place.

WARNING



Cutting or Entanglement Hazard
Operating the rotary cutter without the safety shields can result in physical injury or death. Make sure all shields are properly installed before operating the rotary cutter. This equipment should never be operated with any safety shielding removed.

1.4 Intended Usage

Do not use this rotary cutter for any other purpose than its intended use; cutting grass, weeds, and light brush.

1.5 Operator Orientation

The directions left, right, front, and rear, as mentioned throughout this manual, are as seen from the tractor operator's seat and facing in the direction of travel.

1.6 Serial Number Location (Typical)

The model number and serial number decals are located to the left of the gearbox.



Model Number _____

Serial Number _____

1.7 Product Improvements

Because Titan Implement, LLC maintains an ongoing program of product improvement, we reserve the right to make improvements in design or changes in specifications without incurring any obligation to install them on units previously sold.

1.8 Disposal of Equipment at End of Useful Life

The Titan Implement, LLC rotary cutter has been designed for the specific purpose of cutting grass, weeds, and light brush. When this unit is no longer capable of doing its designed purpose, it should be dismantled and scrapped. Do not use any materials or components from this unit for any other purpose.

1.9 Unanswered Questions

If you have any questions not answered in this manual or require additional copies or the manual is damaged, please contact your dealer or:

Titan Implement, LLC
P.O. Box 649
232 Industrial Lane
Decatur, TN 37322

Phone: (423) 334-0012
Fax: (423) 334-0023

2. Safety

2.1 General

Safety of the operator and bystanders is one of the main concerns in designing and developing a new piece of equipment. Designers and manufacturers build in as many safety features as possible. However, every year many accidents occur which could have been avoided by a few seconds of thought and a more careful approach to handling the equipment.

Most work-related accidents are caused by failure to observe basic safety rules or precautions. An accident can often be avoided by recognizing potentially hazardous situations before an accident occurs. As you assemble, operate, or maintain the rotary cutter (unit), you must be alert to potential hazards. You should also have the necessary training, skills, and tools to perform any assembly or maintenance procedures.

Improper operation and maintenance of this unit could result in a dangerous situation that could cause injury or death.

If you have any questions not answered in this manual or require additional copies or the manual is damaged, please contact your dealer or:

Titan Implement, LLC
P.O. Box 649
232 Industrial Lane
Decatur, TN 37322
Phone: (423) 334-0012
Fax: (423) 334-0023

WARNING



Do not assemble, operate, or maintain the unit until you read and understand the information contained in this manual.



Safety precautions and warnings are provided in this manual and on the unit. If these hazard warnings are not heeded, bodily injury or death could occur to you or to other persons.

Titan Implement, LLC cannot anticipate every possible circumstance that might involve a potential hazard. The warnings in this manual and on the unit are, therefore, not all-inclusive. If a method of assembly, operation, or maintenance not specifically recommended by us is used, you must satisfy yourself that it is safe for you and for others. You should also ensure that the unit will not be damaged or be made unsafe by the methods that you choose.

The information, specifications, and illustrations in this manual are based on the information that was available at the time this material was written and can change at any time without notice.

2.2 Safety Alert Symbols



This is the safety alert symbol (triangle) and will be accompanied with a descriptive pictorial. It is used to alert you to potential personal injury hazards. Obey all safety messages that follow this symbol to avoid possible injury or death.

This manual contains DANGERS, SAFETY INSTRUCTIONS, CAUTIONS, IMPORTANT NOTICES, and NOTES which must be followed to prevent the possibility of improper service, damage to the equipment, personal injury, or death. The following key words call the readers' attention to potential hazards.

Hazards are identified by the "Safety Alert Symbol" and followed by a signal word such as "DANGER", "WARNING", or "CAUTION".

DANGER

Indicates an imminently hazardous situation which, if not avoided, will result in death or serious injury. This signal word is limited to the most extreme situations.

WARNING

Indicates a potentially hazardous situation which, if not avoided, could result in death or serious injury.

CAUTION

Indicates a potentially hazardous situation which, if not avoided, may result in minor or moderate injury.

NOTICE

Indicates that equipment or property damage can result if instructions are not followed.

SAFETY INSTRUCTIONS

Safety instructions (or equivalent) signs indicate specific safety-related instructions or procedures.

Note: Contains additional information important to a procedure.

2.3 Safety Icon Nomenclature

Pictorial icons signal a type of hazard and warn of personal protection issues, prohibited actions, and hazard avoidance.

2.3.1 Personal Protection/ Important Information







-  Read the manual
-  Maintenance procedure
-  Damaged hazard label
-  Eye protection
-  Fire extinguisher
-  First aid kit
-  Hand protection
-  Head protection
-  Hearing protection
-  Inspect equipment
-  OEM parts only
-  Protective shoes
-  Remove key
-  Set parking brake
-  Stop engine
-  Think safety
-  Transmission in park
-  Use proper support
-  Use proper tools

-  Use two people when lifting heavy objects
-  Visibility
-  Rollover protection
-  Wear seat belt
-  Weight rating
-  Chemical flushing kit

2.3.2 Prohibited Actions

-  Do not alter or modify
-  Use proper tools
-  Do not weld
-  No alcohol
-  No drugs
-  No smoking
-  No young children
-  No riders

2.3.3 Hazard Avoidance

-    Crush hazard
-  Crush hazard (chock wheels)
-  Crush hazard (foot)
-  Defective or broken part
-  Entanglement hazard

-  Explosive force hazard
-  Explosive separation hazard
-  Fall hazard
-  Fire hazard
-  Cutter blade contact hazard (hand)
-  Cutter blade contact hazard (foot)
-  Lifting hazard
-  Cutting hazard
-  Pinch point hazard
-  Projectile hazard
-  Rollover protection
-  Safety alert symbol
-  Safety shields
-  Sharp object hazard
-  Slipping injury
-  Tire pressure
-  Tripping injury

2.4 General Safety Instruction

The owner/operator is responsible for the SAFE use and maintenance of the rotary cutter. Make sure anyone who is operating, maintaining, or working around the rotary cutter is familiar with the operating and maintenance procedures and related SAFETY information contained in this manual. This manual will take you step-by-step through your working day and alerts you to all good safety practices that should be used while using the rotary cutter.

In addition to the design features of the rotary cutter, including safety signs, accident prevention is dependent upon the awareness, concern, prudence, and proper training of the people involved in the operation, maintenance, and storage of the rotary cutter.

In addition to this safety section, refer also to safety messages and instructions in each of the appropriate sections of the rotary cutter manual.

These general safety instructions apply to the overall use and maintenance of the rotary cutter.

More specific instructions on safety are found in the operation, maintenance, and storage sections of this manual. Refer to these sections before performing any of these tasks.

WARNING

Failure to comply with the following safety instructions can and will result in serious injury and possibly even death if they are not understood and followed.



Read and Understand Manual

To prevent personal injury or even death, be sure you read and understand all of the instructions in this manual and other related OEM equipment manuals! The Titan Implement, LLC rotary cutter, if not used and maintained properly, can be dangerous to users unfamiliar with its operation. Do not allow operating, maintaining, adjusting, or cleaning of this rotary cutter until the user has read this manual and has developed a thorough understanding of the safety precautions and functions of the unit.

This rotary cutter is designed for the specific purpose of cutting grass, weeds, and light brush. DO NOT modify or use this rotary cutter for any application other than that for which it was designed.

Rotary cutters maintained or operated improperly, or by untrained personnel, can be dangerous; exposing the user and/or bystanders to possible serious injury or death.

WARNING



Provide User with Literature

Titan Implement, LLC rotary cutter owners must provide operator instructions to anyone using the rotary cutter before use, and at least annually thereafter. Refer to “2.6 OSHA Training Requirements” on page 13.



Stay Clear

Clear the area of people, especially small children, before using the rotary cutter. Under no circumstances should young children be allowed to work with or around the rotary cutter.



Impaired User Hazard

Do not attempt to assemble, operate, or maintain this rotary cutter under the influence of drugs or alcohol. Consult your doctor before using this rotary cutter while taking prescription medications.



Crush Hazard

Do not allow anyone to ride on the tractor or the rotary cutter. Falling or crushing hazards can result in severe injuries or death.



Falling Hazard

Do not allow riders on the hitch, tractor, or rotary cutter at any time. Falling can result in severe injuries or death.



No Unauthorized Modifications

Do not modify the rotary cutter or safety devices. Do not weld on the unit. Unauthorized modifications may impair its function and safety. Personal injury or death can result from unauthorized modifications.

If the rotary cutter has been altered in any way from the original design, Titan Implement does not accept any liability for injury or warranty.



Damaged Parts Hazard

Do not use the rotary cutter if any parts are damaged. If the rotary cutter has a defect, immediately stop using it and remedy the problem before continuing.



Thrown Objects Hazard

Rotary cutter can throw objects up to 300 feet. To avoid serious injury or death: Keep all thrown object shielding in place. Inspect area for potential thrown objects before cutting.

Do not operate the rotary cutter with the deck raised.

⚠️ WARNING



Safety Shields

Some illustrations in this manual show the equipment with safety shields removed to provide a better view. This equipment should never be operated with any necessary safety shielding removed.

⚠️ CAUTION

The following safety instructions are provided to help prevent potential injury. Not following these instructions may lead to injury.

Personal Protection Equipment

When using this rotary cutter, wear appropriate personal protective equipment. This list may include, but is not limited to:



- Protective shoes with slip resistant soles
- Protective goggles, glasses, or face shield
- Protective clothing and gloves
- Safety vest (when operating near roads)
- Hearing protection



Ear Protection

Wear suitable ear protection during prolonged exposure to excessive noise.



Hearing Loss

Prolonged Exposure To Loud Noise May Cause Permanent Hearing Loss!

Working environments with noise-producing equipment can cause partial to permanent hearing loss. We recommend using hearing protection any time noise levels exceed 80 decibels (dB). Noise levels over 85 dB, on a long-term basis, can cause severe hearing loss. Noise levels over 90 dB over a period of time can cause permanent and even total hearing loss.

Hearing loss from loud noise is cumulative over a lifetime without hope of natural recovery.



Crush Hazard

The tractor should be equipped with a Roll Over Protective Structure (ROPS) and a seat belt. A crushing hazard can occur if the driver is ejected from the seat while the tractor is in motion. Fasten the seat belt whenever the tractor is moving.

SAFETY INSTRUCTIONS

The following safety instructions are provided to help prevent injury or limit equipment damage.



Safety Signs

Replace any missing or hard-to-read safety signs or instructional labels. Use care when washing or cleaning the rotary cutter.

Replacement safety sign locations and part numbers are provided in this manual and are available from an authorized dealer parts department or the factory.



First Aid Kit

Have a first aid kit available for use should the need arise and know how to use it.



Fire Extinguisher

Have a fire extinguisher available for use should the need arise and know how to use it.



Think SAFETY!

Work SAFELY!

2.5 Training

Anyone who will be using and/or maintaining the rotary cutter must read, clearly understand, and follow ALL safety, operation, and maintenance information presented in this manual, other related OEM manuals, and the safety signs

If you do not understand any information in this manual, see your dealer or contact Titan Implement before proceeding.

Do not use or allow anyone else to use this rotary cutter until all information has been reviewed. Annually review this manual before the season start-up.

Make periodic reviews of SAFETY and OPERATION of the rotary cutter a standard practice. An untrained operator is not qualified to use this rotary cutter.

2.6 OSHA Training Requirements

The following training requirements have been taken from Title 29, Code of Federal Regulations Part 1928.57 (a) (6). www.osha.gov.

Operator instructions. At the time of initial assignment and at least annually thereafter, the employer shall instruct every employee who operates an agricultural tractor and implements in the safe operating practices and servicing of equipment with which they are or will be involved, and of any other practices dictated by the work environment.

2.7 Federal Laws and Regulations

IMPORTANT FEDERAL LAWS AND REGULATIONS CONCERNING EMPLOYERS, EMPLOYEES AND OPERATORS

This sections is intended to explain in broad terms the concept and effect of the following federal laws and regulations. It is not intended as a legal interpretation of the laws and should not be considered as such.

U.S. PUBLIC LAW 91-596 (The Williams-Steiger Occupational and Health Act of 1970) OSHA

This Act Seeks:

" ... to assure so far as possible every working man and woman in the nation safe and healthful working conditions and to preserve our human resources ... "

DUTIES

Sec. 5(a) Each Employer -

- (1) shall furnish to each of its employees employment and a place of employment which are free from recognized hazards that are causing or are likely to cause death or serious physical harm to its employees.
- (2) shall comply with occupational safety and health standards promulgated under this Act.
 - (b) Each employee shall comply with occupational safety and health standards and all rules, regulations, and orders issued pursuant to this Act which are applicable to his or her own actions and conduct.

OSHA Regulations

Current OSHA regulations state in part: "At the time of initial assignment and at least annually thereafter, the employer shall instruct every employee in the safe operation and servicing of all equipment with which the employee is, or will be involved." These will include (but are not limited to) instructions to:

Keep all guards in place when the machine is in operation;

Permit no riders on equipment;

Stop engine, disconnect the power source, and wait for all machine movement to stop before servicing, adjusting, cleaning, or unclogging the equipment, except where the machine must be running to be properly serviced or maintained, in which case the employer shall instruct employees as to all steps and procedures which are necessary to safely service or maintain equipment.

Make sure no one is within 300 feet of machinery before starting the engine, engaging power, or operating the machine.

EMPLOYEE TRACTOR OPERATING INSTRUCTIONS:

1. Securely fasten your seat belt if the tractor has a ROPS.
2. Where possible, avoid operating the tractor near ditches, embankments, and holes.
3. Reduce speed when turning, crossing slopes, and on rough, slick, or muddy surfaces.
4. Stay off slopes too steep for safe operation.
5. Watch where you are going, especially at row ends, on roads, and around trees.
6. Do not permit others to ride.
7. Operate the tractor smoothly - no jerky turns, starts, or stops.
8. Hitch only to the drawbar and hitch points recommended by tractor manufacturers.
9. When tractor is stopped, set brakes securely and use park lock if available.

Child Labor Under 16 Years Old

Some regulations specify that no one under the age of 16 may operate power machinery. It is your responsibility to know what these regulations are in your own area or situation. (Refer to U.S. Dept. of Labor, Employment Standard Administration, Wage & Home Division, Child Labor Bulletin #102).

2.9 Operation

Refer to the Operation Section for safety recommendations related to using the rotary cutter. All applicable safety recommendations in other sections should also be followed.

2.10 Transporting

Refer to the Transporting Section for safety recommendations related to transporting the rotary cutter. All applicable safety recommendations in other sections should also be followed.

2.11 Storage

Refer to the Storage Section for safety recommendations related to storing the rotary cutter. All applicable safety recommendations in other sections should also be followed.

2.12 Maintenance

Refer to the Service and Maintenance Section for safety recommendations related to maintaining the rotary cutter. All applicable safety recommendations in other sections should also be followed.

3. SAFETY SIGNS AND INSTRUCTIONAL LABELS

3.1 General Information

The types of safety signs (hazard labels) and instructional labels, along with their locations on the equipment, are shown in the following illustrations. Good safety practices require that you familiarize yourself with the various safety signs, the type of warning, and the area or particular operation related to that area that requires your SAFETY AWARENESS.



Think SAFETY!

Work SAFELY!

Pay close attention to the safety signs and instructional labels attached to the tractor and the rotary cutter. Duplicate safety signs, which are attached to the rotary cutter, can also be found in this section. If the rotary cutter is missing a label or one is unreadable, replace the label before using the rotary cutter.

SAFETY INSTRUCTIONS



Safety Signs and Instructional Labels

1. **Keep safety signs or instructional labels clean and legible at all times. Use a clean, damp cloth to clean safety decals.**
2. **Replace any missing or hard-to-read safety signs or instructional labels.**
3. **Use care when washing or cleaning the equipment not to remove or damage the labels. When using a pressure washer to clean the rotary cutter, avoid spraying too close to decals; high-pressure water can enter through very small scratches or under edges of decals causing them to peel or come off.**
4. **Locations for the labels and replacement part numbers are shown in this section.**
5. **Replacement parts must have replacement labels attached during installation and/or before the rotary cutter is used.**
6. **Labels are available from your authorized dealer or from Titan Implement at no charge.**

3.2 How to Install Replacement Safety Signs

1. Clean and dry the installation area.

Note: Do not install the signs if the temperature is below 50°F.

2. Determine the exact position before you remove the backing paper.
3. Remove the backing paper.
4. Align the sign over the specified area and carefully press the sign to the part/frame.

Note: Small air pockets can be pierced with a pin and smoothed out using the piece of backing paper.

3.3 Safety Sign Locations

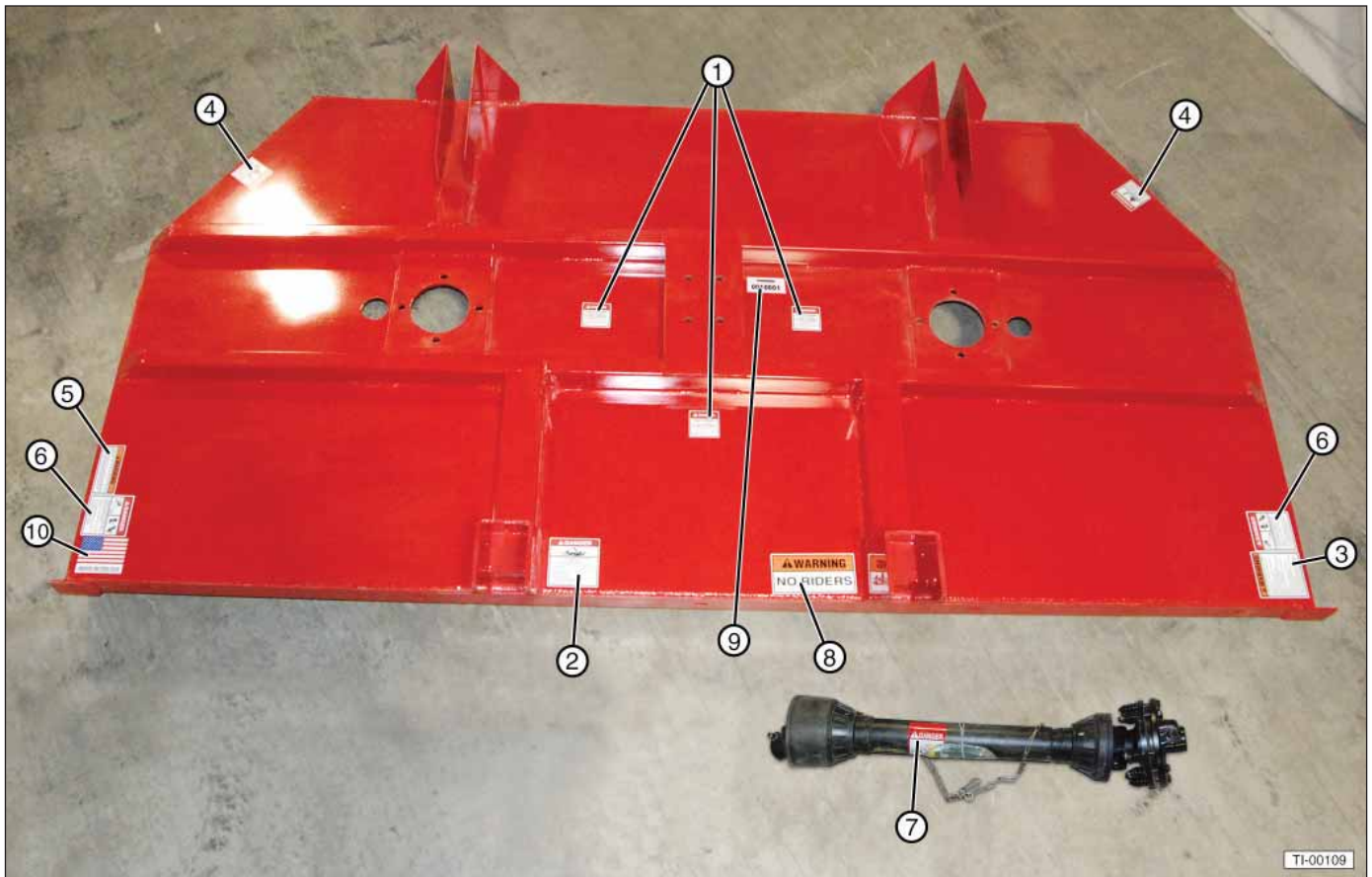

Safety Sign Locations.

Item	Type	Description	Qty.
1	DANGER	Guard Missing, Do Not Operate	3
2	DANGER	Driveline Hazard	1
3	WARNING	Multi-Hazard	1
4	DANGER	Thrown Object Hazard	2
5	WARNING	Safety Shields	1
6	DANGER	Rotating Blades Hazard	2
7	DANGER	Rotating Driveline, Keep Away, Outer Shield Tube	1
8	WARNING	No Riders	1
9	SERIAL	Serial No.	1
10	INSTRUCTIONAL	Made In the USA	1

3.3.1 Cutter Deck Safety Signs

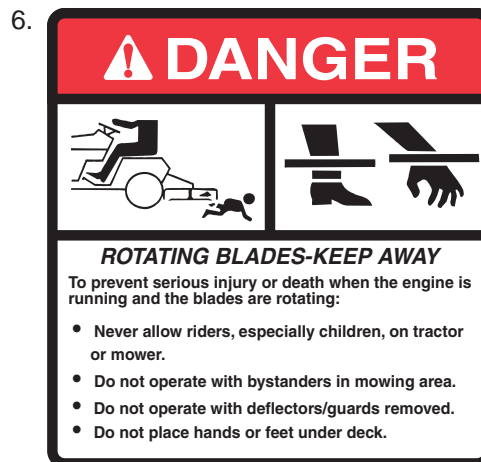
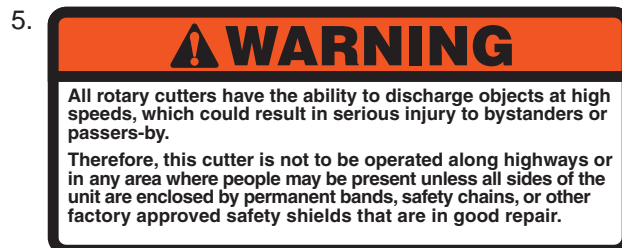
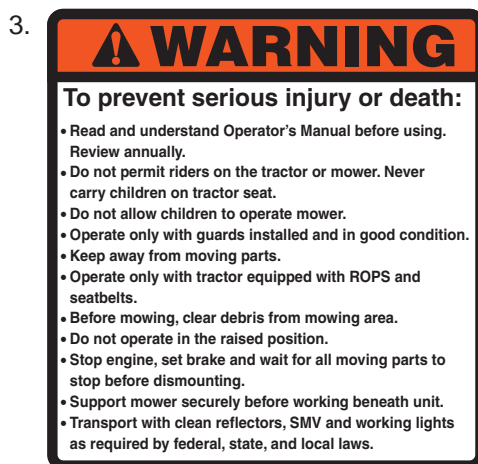
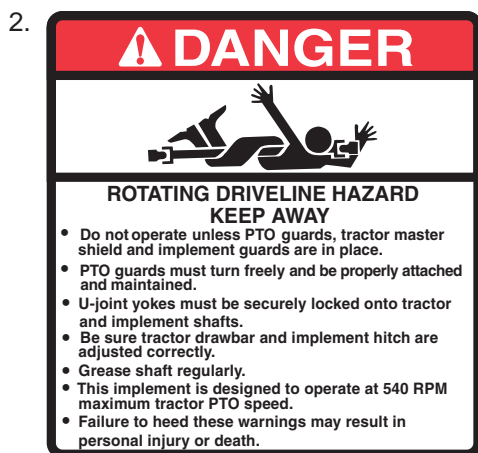

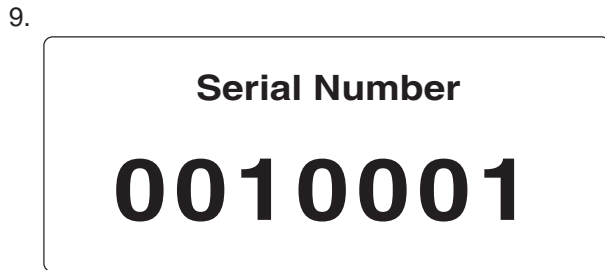

4. Nomenclature

4.1 Description and Intended Use

The rotary cutter is designed for heavy duty applications such as weeds, grass, and brush up to 3" diameter. The cutter uses dual spindles with two free-swinging blades each, which reduce the shock of impact when a stationary object is contacted. A slip clutch and dual shock couplers protect the gearboxes and driveline from damage. Standard equipment includes driveline shields and clutch shields. Front and rear chain discharge shields are optional.



4.1.1 Owner/Operator Manual Storage

Always store the Owner/Operator manual and other operating materials in the document storage tube.



4.2 Nomenclature

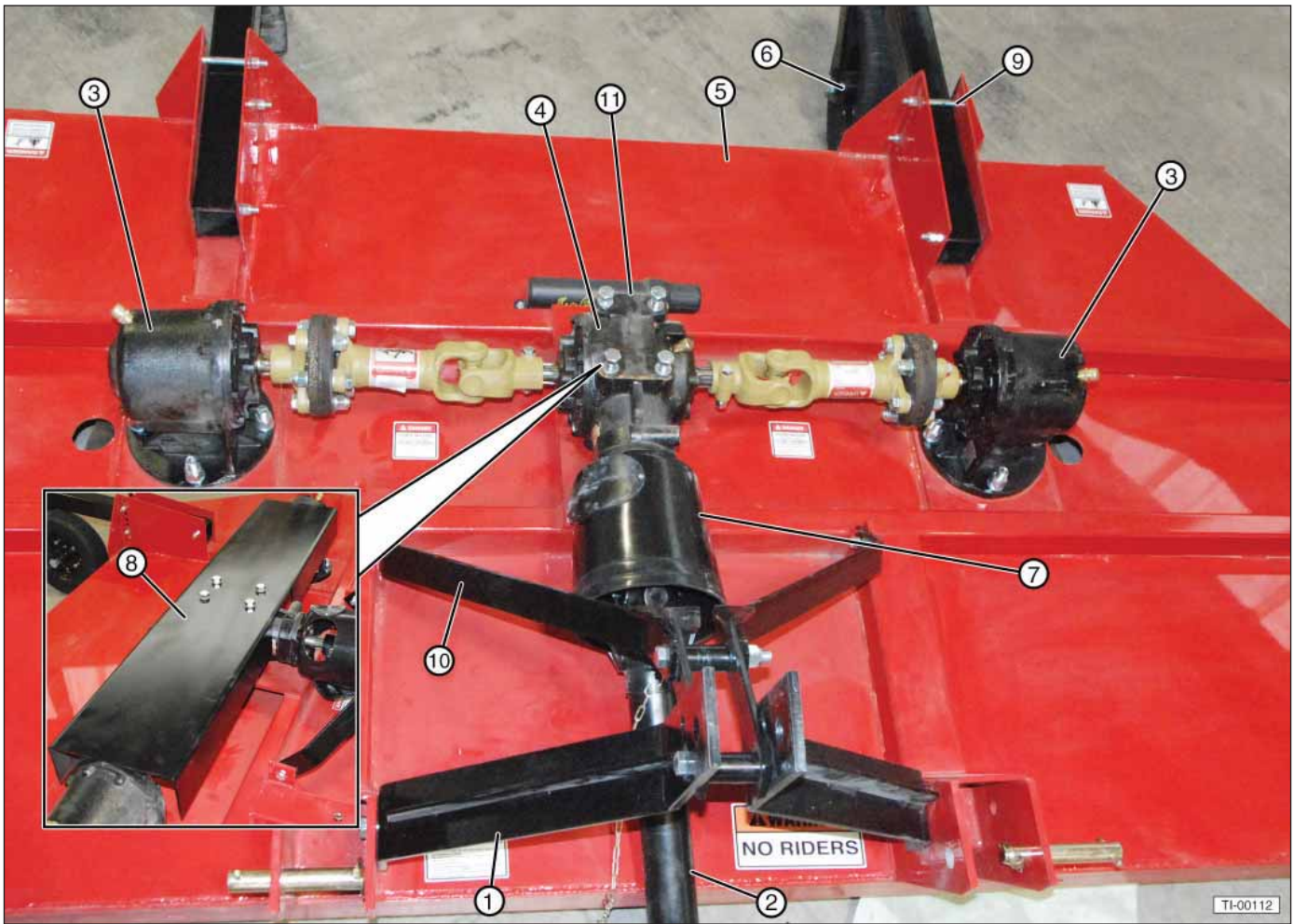

Item	Description	Qty.
1	A-Frame	1
2	Driveline	1
3	Gearbox	2
4	Center Tee Gearbox	1
5	Cutter Deck	1
6	Tailwheel	1
7	Driveline Shield	1
8	Center Gearbox Shield	1
9	Adjusting Bolts	1
10	Back Braces	1
11	Document Storage Tube	1

5. Assembly

5.1 Tools Required

Tools Required
Wrenches, 1/2", 5/8", 3/4", 1-1/8", 1-3/8"
Ratchet with extension and 3/4" socket

5.2 Assembly Procedure

1. Verify that all parts shown are included. If any parts are missing, contact your Titan Implement dealer.



2. Cut the wires holding the driveline parts to the A-frame. Set the driveline aside for now.



3. Remove the driveline shield from its shipping location on the rear of the deck.



4. Stand the A-frame up and remove the 5/8-11 x 5" bolt, locknut, and spacer on the break link.



5. Position the back braces on the outside of the break link and reinstall the bolt and spacer. Be sure the spacer is in place.



6. Tighten the bolt sufficiently to eliminate side play, but still allow the break link to function.



7. Remove the four 5/16-18 x 1/2" bolts and washers from the front of the gearbox.



8. Remove the three bolts holding the driveline shield backplate to the shield.

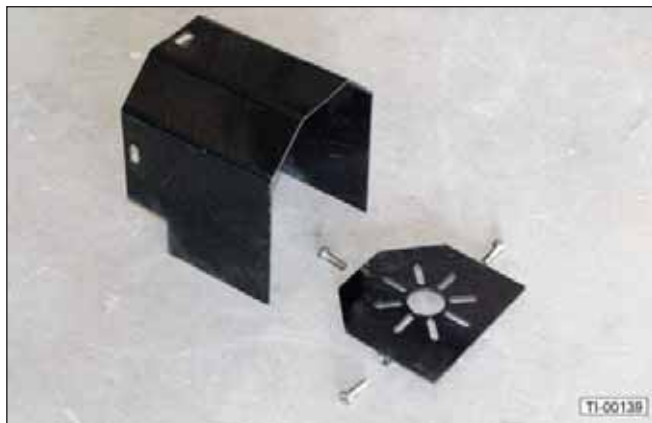

9. Position the driveline shield backplate on the front of the gearbox and re-install the four 5/16-18 x 1/2" bolts and washers. Make sure the nuts welded to the backplate are positioned toward the front of the unit.

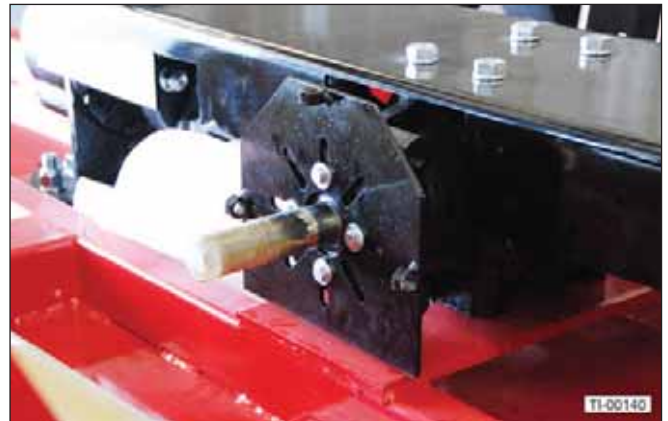

10. Separate the two halves of the driveline.



11. Remove the retaining bolt from the slip clutch.



12. Line up the spline grooves and slide the slip clutch onto the gearbox input shaft until the retaining bolt hole aligns with the groove in the shaft.



13. Install the retaining bolt and tighten the locknut.



⚠ WARNING



Crush Hazard

If the retaining bolt is not present, the driveline may separate from the gearbox, causing serious injury or death. Do not omit the retaining bolt. Tighten the locknut securely.

14. Apply a bead of grease around the end of the inner drive shaft.



15. Slide the front driveline half over the rear half. Align the square rib on the mating halves to engage.

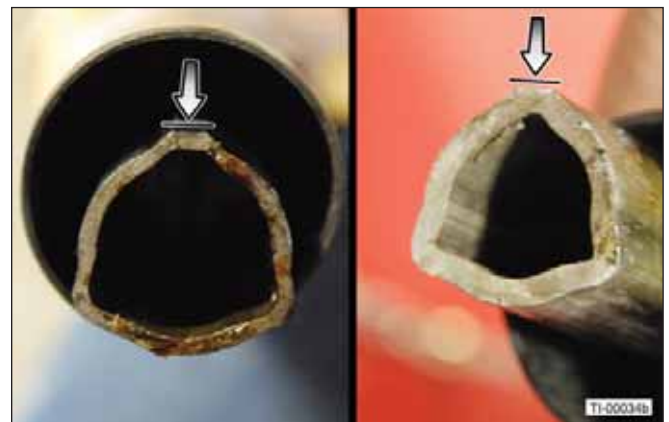

16. Apply grease to the zerk on the U-joint cross.



19. Apply grease to the zerk on the tailwheel forks.



17. Position the gearbox shield to the backplate and install the three 1/2-13 x 1-1/2" bolts.



20. Apply grease to the zerk on the tailwheel hubs.



18. Attach the chain on the outer driveline shield to the rotary cutter.



5.3 Installation and Removal of Driveline to Tractor PTO

WARNING



Entanglement Hazard

To avoid serious injury or death from driveline contact:

Shut off tractor PTO and disengage before dismounting.

Do not operate PTO if shields are missing or damaged.

Keep hands, feet, and body away from rotating parts.

To install the driveline:

1. Turn the tractor off, set the parking brake, and remove the key.
2. Depress the locking pin on the tractor end of the driveline.



3. Push the driveline onto the tractor PTO shaft until the locking pin engages.



To remove the driveline:

1. Depress the locking pin on the tractor end of the driveline.
2. Slide the driveline off the tractor PTO shaft.

5.4 Checking the Driveline Length

Before operating the rotary cutter, make sure the driveline will not bottom out or become disengaged. Bottoming out occurs when the inner shaft penetrates the outer housing until the assembly can shorten no more. Bottoming out can cause serious damage to the tractor PTO by pushing the PTO into the tractor and through the support bearings or downward onto the PTO shaft, breaking it off. A broken driveline can cause personal injury.

1. Attach the rotary cutter to the tractor 3-point hitch. Do not attach the driveline. Keep the driveline out of the way of moving parts.
2. Raise and lower the rotary cutter to determine the maximum and minimum distance between the tractor PTO shaft and the gearbox input shaft. If the distance is too large, the driveline will be too short for proper engagement. If the distance is too small, the driveline may bottom out in operation and damage the rotary cutter or tractor.

There must be at least six inches of engagement at the rotary cutter's lowest possible point of operation, and the driveline must not bottom out when raised to the maximum height possible. If the driveline is too short, please call your Titan Implement dealer for a longer driveline. If the driveline is too long, follow the instructions for shortening the driveline.

5.5 Shortening the Driveline

1. Move rotary cutter up and down to get the shortest possible distance between tractor PTO shaft and gearbox input shaft. Shut down tractor PTO shaft and gearbox input shaft. Shut down tractor leaving rotary cutter in position of shortest distance. Securely block rotary cutter in position.
2. Separate driveline into two halves and connect them to the tractor PTO and gearbox.
3. Place driveline halves parallel to one another to determine how much to shorten the driveline.
4. Each section should end approximately 3" short of reaching the universal joint shield on the opposite section. If too long, measure 3" back from the universal joint shield and mark on the opposite section.
5. Repeat Step 4 for the other half of the drive.
6. Raise and lower rotary cutter to determine position with greatest distance between PTO shaft and gearbox input shaft. Shut down tractor leaving rotary cutter in position of greatest distance. Securely block rotary cutter in position.

7. Hold driveline sections parallel to each other and check for minimum 6" overlap. If driveline has been marked for cutting, overlap will be the distance between two marks. If driveline has less than minimum overlap, do not use. Contact your Titan Implement dealer.

Note: If driveline is the correct length, omit the following Steps 8 - 9 and proceed to Step 10.

8. Clamp a driveline section in a well padded vice to prevent damage to the shield. Cut off the shield where marked. Using the cut off section of the shield as a guide, cut the shaft the same amount. Repeat for the other driveline section.

9. File and clean the cut ends of both drive halves. Remove all chips and filings.

10. Apply multi-purpose grease around the inner driveline section. Slide drive halves over each other several times to distribute the grease. Install driveline on tractor and rotary cutter. Make certain driveline shielding is in place and in good condition.

Note: Do not use the rotary cutter if proper driveline engagement cannot be obtained through these methods. Contact your Titan Implement dealer.

11. Set the tractor lift control stop to a position that will prevent the driveline from contacting the front edge of the rotary cutter deck when the rotary cutter is raised fully.

6. Operation

6.1 User Safety Training

Refer to “2.4 General Safety Instruction” on page 12 for user safety training requirements.

WARNING



Roll Away Hazard

Before leaving the tractor seat, make sure the engine is stopped, the transmission is placed in park, the key is removed, and the parking brake is set.



The weight of the tractor, plus the rotary cutter if it rolls onto a person, can cause serious crushing injury or death.

SAFETY INSTRUCTIONS

The following safety instructions are provided to help prevent injury or limit equipment damage.



Train Unfamiliar Users

It is the rotary cutter owner’s responsibility to make sure any person using the rotary cutter, especially if it is loaned or rented, has been thoroughly trained on its proper and safe use.

Train all new users and review instructions annually with existing users.

Be certain only physically-able persons will use the rotary cutter.

Users who have not read and understood all operating and safety instructions are not qualified to use the rotary cutter.

Untrained users expose themselves and bystanders to possible serious injury or death.

If the elderly are assisting with the work, their physical limitations need to be recognized and accommodated.

Never allow children to operate equipment.

6.2 Tractor Requirements



WARNING



Tractor Owner/Operator Manual Always refer to the tractor owner’s manual to ensure compatibility and maximum safety.

The tractor used to operate the cutter must have the power capacity to lift, pull, and operate the Power Take Off (PTO) at the cutter’s rated speed while traveling at a ground speed between 2 and 5 MPH.

The tractor must be matched to the weight of the rotary cutter. A minimum of 20% of the combined tractor and equipment weight should be on the front wheels. This will ensure adequate stability during transport and operation.

Operating the cutter with a tractor that does not meet the following requirements may cause tractor or cutter damage and be a potential danger to the operator and passersby.

Always review the “controls” section of the tractor operator’s manual to be familiar with the location, settings, and function of the tractor controls. Be familiar with all controls before using this equipment.

6.2.1 Tractor Requirements and Capabilities

- ASABE approved Roll-Over Protective Structure (ROPS) or ROPS cab and seat belt.
- Tractor Safety Devices; Slow Moving Vehicle (SMV) emblem, lighting, PTO master shield
- 3-Point Hitch, CAT II/QH
- Front End Weight as needed to maintain 20% weight on front axle.
- To reduce the risk of grass fires, do not operate the cutter on a tractor with an underframe exhaust.

6.2.2 Tractor Safety Devices

If transporting or operating the tractor and implement near a public roadway, the tractor must be equipped with proper warning lighting and a Slow Moving Vehicle (SMV) emblem which are clearly visible from the rear of the unit. Lights and a SMV emblem must be equipped directly on implements if the visibility of the tractor warning signals are obscured.

Maintain all manufacturer equipped safety shields and guards. Always replace shields and guards that were removed for access to connect, service, or repair the tractor or implement. Never operate the tractor PTO with the PTO master shield missing or in the raised position.

6.2.3 ROPS and Seat Belt



Rollover Hazard

To avoid serious injury or death from falling off tractor, equipment rollover, rollover, or crushing:

- 1) Use ROPS equipped tractor.
- 2) Keep ROPS locked in the UP position.
- 3) Only operate the equipment when seated in the tractor seat.
- 4) Always fasten seat belt when operating the tractor and rotary cutter.

The tractor must be equipped with a Roll Over Protective Structure (ROPS) (tractor cab or roll bar) and seat belt to protect the operator from falling off the tractor, especially during a roll-over where the driver could be crushed and killed. Only operate the tractor with the ROPS in the raised position and seat belt fastened.

Tractor models not equipped with a ROPS and seat belt should have these life saving features installed by an authorized dealer.

6.2.4 3-Point Hitch

These rotary cutters are designed to be mounted on a tractor CAT II 3-Point or Quick Hitch.

Refer to the tractor operator's manual for the category of the tractor being used. If the hitch does not conform to ASABE CAT II dimensions, the rotary cutter may not fit or raise properly. Consult an authorized dealer for possible modification procedures to mount non-conforming hitches. Depending on the hitch category, certain size pins are used to attach the rotary cutter to the tractor. CAT II hitches require 1-1/8" lower and 1" upper diameter hitch pins.

6.2.5 Tractor Horsepower

The power required to operate the cutter is determined by the tractor PTO horsepower. Operating the cutter with a tractor that does not have adequate power may damage the tractor engine. Exceeding recommended HP may cause rotary cutter damage by overpowering the unit in heavy cutting conditions.

Model	Recommended Min. HP	Lifting Capacity (Min.)
1708	42	1250
1808	42	1250
1810	52	1480

6.2.6 Power Take-Off (PTO)

This rotary cutter is designed to operate at a PTO speed of 540 RPM. Most tractors operate at either 540 or a combination of 540 and 1000 RPM PTO speeds. The operating speed of the rotary cutter and tractor can be determined by the number of splines on the driveline yoke and PTO output shaft. Those operating at 540 RPM will have a 6-spline shaft, and those operating at 1000 RPM will have a 21-spline shaft.

Note: The rotary cutter will not operate on tractors equipped with a 1000 RPM 21-spline or 1000 RPM 20-spline, 1-3/4" shaft.

Refer to the tractor owner's manual for instructions to change PTO speeds on models that operate at more than one speed.

If operating an older model tractor where the tractor's transmission and PTO utilize one master clutch, an over-running clutch must be used between the PTO output shaft and the driveline of the rotary cutter. An authorized tractor dealer can provide the over-running clutch and its installation, if needed.

DO NOT use a PTO adapter to attach a non-matching implement driveline to a tractor PTO. Use of an adapter can double the operating speed of the implement, resulting in excessive vibration, thrown objects, and blade and implement failure. Adapter use will also change the working length of the driveline exposing unshielded driveline areas. Serious bodily injury and/or equipment failure can result from using a PTO adapter. Consult an authorized dealer for assistance if the implement driveline does not match the Tractor PTO.

6.3 Attaching to Tractor

Use caution when connecting the rotary cutter to the tractor. The rotary cutter should be securely resting at ground level or setting on blocks. Keep hands and feet from under the deck and clear of pinch points between the tractor hitch arms and rotary cutter hitch pins.

WARNING



Crush Hazard

Crush hazard between hitch and implement. Do not allow anyone to stand between the hitch and implement during hook-up operations. Never operate the hydraulic 3-point lift controls while someone is directly behind the tractor.

1. Shorten or remove the tractor drawbar to avoid interference when raising and lowering the rotary cutter.
2. Board the tractor and start the engine. Position the tractor with the 3-point lift arms positioned at the same height and to the outside of the rotary cutter hitch pins.

Note: Set the 3-point lift control to “Position Control” so that the lift arms maintain a constant height when attaching the rotary cutter. See the tractor Operator’s Manual for correct settings when attaching 3-point equipment.

3. Turn off the tractor engine and dismount.
4. One lift arm at a time, insert hitch pin through the lift arm holes and install retaining pin.
5. Walk around to the opposite side and repeat the procedure for the remaining lift arm and hitch pin.
6. Extend or retract 3-point top link to align its end hole with the holes of the rotary cutter’s top link. Insert the top link hitch pin and insert the retaining pin into the hitch pin.
7. Adjust any lower link check chains, guide blocks, or sway blocks to prevent the rotary cutter from swaying side-to-side and possible contact with the tractor rear tires.
8. Depress the locking pin on the tractor end of the driveline.
9. Push the driveline onto the tractor PTO shaft until the locking pin engages.

6.4 Detaching from Tractor

1. Move the rotary cutter to a level storage location and lower it to the ground or onto blocks. Park the tractor, place the transmission in park or neutral, and apply the parking brake. Shut down the engine, remove the key, and wait for all motion to come to a complete stop before exiting the tractor. Before disconnecting the rotary cutter, the PTO must be disengaged and blade rotation at a complete stop.
2. Make sure the rotary cutter is resting securely on the ground or blocks before attempting to disconnect it from the tractor. Use extreme care to keep feet and hands from under the rotary cutter and clear of any pinch points caused by the tractor hitch arms and rotary cutter hitch pins.
3. Extend the tractor 3-point hitch top link to remove tension on the top link hitch pin. When the pin is loose and easy to rotate, remove the pin from the rotary cutter.



4. Disconnect the lift arms and remove the rotary cutter driveline from the tractor PTO shaft. Lay the driveline down carefully to avoid damaging the driveline or its shield. Do not let the driveline fall into mud or dirt, which can contaminate the bearing and shorten the life of the driveline.



6.5 Setting the Rotary Cutter

Properly setting the cutting height is essential for efficient and safe operation. A properly set rotary cutter will make a more uniform cut, distribute clippings more evenly, require minimal tractor work, and follow the contour of uneven terrain.

Note: Avoid very low cutting heights. Striking the ground with the blades causes damaging shock loads and will cause damage to the rotary cutter and drive. Blades contacting the ground may cause objects to be thrown out from under the cutter deck. Always avoid operating the rotary cutter at a height which causes the blades to contact the ground.

6.5.1 Setting the Cutting Height

The rotary cutter should be operated at the highest position which will give desired cutting results. This will help prevent the blades from striking the ground, increasing blade life, and reducing stress on the rotary cutter and tractor.

1. Park the tractor and rotary cutter on level ground.
2. Using the 3-point hitch control lever, position the front of the rotary cutter with the side skids 1" lower than the desired cut height. For example, for a 3" cut, position the skids 2" from the ground. Set the 3-point control lever stop at this position to maintain this height when raising and lowering the cutter.
3. Shut off the tractor and remove the key.
4. Adjust the rotary cutter deck pitch by extending or retracting the 3-point top link.
 - a. To increase fuel efficiency and lower horsepower requirements for rotary cutter operation, the rotary cutter should be operated with the deck approximately 3/4" lower in the front than the rear.
Operating the rotary cutter at this pitch will allow the rotary cutter to cut the grass only once and requires less work from the tractor.
 - b. To increase mulching of the grass or crop material during rotary cutter operation, the rotary cutter should be operated with the deck approximately 3/4" higher in the front than the rear.
Operating the rotary cutter at this pitch will allow the rotary cutter to cut the grass twice and can result in a more even cut and improved distribution of the cut material.

5. Level the rotary cutter side-to-side by manipulating one lower lift arm length. On most tractors, at least one of the lift arms is designed to allow for manipulation of its length. Shortening or extending the lift arm will allow for deck leveling from side-to-side.
6. Securely block up the rotary cutter at this height.
7. Remove the tailwheel adjustment bolts and allow both tailwheels to rest at ground level. Align the nearest set of holes in the tailwheel adjustment and reinstall the support bolts.
8. Extend the tractor's top 3-point link so that when lifting the rotary cutter, the front of the deck will raise 2 to 2½" before the tailwheels leave the ground. This will allow the rotary cutter to follow the contour of uneven terrain.





6.6 Tire and Wheel







Laminated sectional tires are designed for conditions where puncture proof performance is required and the rotary cutter will not be transported for long distances on roadways. Transport speed for laminated tires should not exceed 15 MPH. Excessive speed can cause damage to the machine and tire sections.

6.7 Initial Setup Checklist

Efficient and safe operation of the rotary cutter requires that every user read and understand the operational instructions and all related safety instructions outlined in this manual.

This Initial Setup Checklist is provided for the user/owner. It is important for both personal safety and to maintain the mechanical condition of the rotary cutter that this checklist is followed.

Initial Setup Checklist (prior to using for the first time)		
✓	Location	Task
		Verify all safety signs are in place and legible. Refer to "3.3 Safety Signs" on page 18.
		Make sure the rotary cutter is properly mounted to the 3-point hitch. Refer to "6.3 Attaching to Tractor" on page 31.
		Make sure the driveline is attached to the tractor PTO. Refer to "6.3 Attaching to Tractor" on page 31.
		Make sure all hardware is properly installed and tightened. Refer to "11.1 Bolt Torque" on page 47.
		Check that the blades are sharp. Refer to "9.5 Blade Servicing" on page 40.

Initial Setup Checklist (prior to using for the first time)		
✓	Location	Task
		Make sure the blade carrier nuts are tight and the cotter pins installed. Refer to "9.6 Blade Carrier Removal" on page 41.
	 	Lubricate all grease zerks and driveline slip joint. Refer to "9.2 Greasing" on page 40.
		Make sure all safety shields and guards are properly installed. Refer to "5.2 Assembly Procedure" on page 23.
		Check the gearbox grease level. Refer to "9.3 Gearbox Lubrication" on page 40.
		Check the tailwheels for damage. Make sure the tailwheel support bolts are tight.
		Check the cutting height. Adjust if needed. Refer to "6.5.1 Setting the Cutting Height" on page 32.

6.8 Machine Break-In

Although there are no operational restrictions on the rotary cutter when used for the first time, it is recommended that the following mechanical items be checked:

1. After 1/2 hour of operation:
 - a. Tighten all fasteners if necessary.
 - b. Lubricate all grease fittings.
2. After 10 hours of operation:
 - a. Go to the normal servicing and maintenance schedule, as defined in the Maintenance Section.

6.9 Pre-Operation Checklist

Before each use of the rotary cutter, the following areas should be checked.

Checklist Before Each Use	
✓	Task
	Make sure the rotary cutter is positively attached to the tractor 3-point hitch.
	Use only an appropriately sized tractor to pull the rotary cutter. Refer to "6.2 Tractor Requirements" on page 29.
	Make sure the driveline is attached to the tractor PTO.
	Make sure all safety shields and guards are properly installed.
	Check the blade bolts and blade pan nut.
	Check the condition of the blades.
	Check the cutting height. Adjust if needed.
	Inspect the overall rotary cutter for potential problems or damage. Do not use the rotary cutter if it needs repairs of any type.

6.10 Operation Checklist

Although the rotary cutter is easy to use, each operator should review this section to familiarize themselves with the detailed safety and operating procedures. When using this machine, follow this procedure:

1. Clear the area of bystanders, especially small children.
2. Clear the area to be cut of stones, branches, debris, and any hard objects that may be thrown.
3. Mark the location of objects that cannot be removed.
4. Review and follow the Pre-Operation Checklist.
5. Engage the PTO at low engine RPM, then raise PTO speed to 540 RPM.
6. Begin cutting at a slow speed, then increase to a speed that gives a clean cut without lugging the engine. Do not operate above 5 MPH.
7. Never allow blades to contact solid objects like rocks, posts, wire, curbs, guardrails, or the ground while mowing.
8. Avoid operating the rotary cutter in reverse direction when possible. Check to make sure there are no persons behind the rotary cutter, and use extreme care when maneuvering in reverse.

6.11 Operating Safety

WARNING



Crush Hazard

The tractor should be equipped with a Roll Over Protective Structure (ROPS) and a seat belt. A crushing hazard can occur if the driver is ejected from the seat while the tractor is in motion. Fasten the seat belt whenever the tractor is moving.



Thrown Object Hazard

Cutters can throw objects up to 300 feet.

To avoid serious injury or death:

- 1) Keep all thrown object shielding in place.**
- 2) Inspect area for potential thrown objects before cutting.**
- 3) Do not operate rotary cutter with the deck raised.**



Thrown Object Hazard

For non-agricultural use, OSHA, ASAE, SAE, and ANSI standards require the use of chain guards or other protective guards at all times.



Stay Clear

Clear the work area of all unnecessary people and obstructions to prevent personal injury.



Cutter Blade Contact Hazard (hand)

To avoid serious injury or death, keep away from rotating blades. Do not put hands under cutter deck.



Cutter Blade Contact Hazard (foot)

To avoid serious injury or death, keep away from rotating blades. Do not put feet under rotary cutter deck.

SAFETY INSTRUCTIONS



Fire Hazard

Clippings are flammable. To reduce the risk of fire:

Do not operate near fires.

Keep rotary cutter deck clear of clippings and debris.



Fire Extinguisher

Carry a fire extinguisher on the tractor at all times.

- Never operate the rotary cutter in an area that you have not inspected and removed debris or foreign material.
- Operate the rotary cutter only in conditions where you have clear visibility in daylight or with adequate artificial lighting. Never operate the rotary cutter in darkness or foggy conditions where you cannot clearly see at least 300 feet in front and to the sides of the tractor and rotary cutter. Make sure that you can clearly see and identify passersby, steep slopes, ditches, drop-offs, overhead obstructions, power lines, debris, and foreign objects. If you are unable to clearly see these type of items, discontinue operating the cutter.
- Do not operate the rotary cutter, or drive the tractor into material that is burning, or areas that recently burnt and may contain hot spots. Burning material, sparks, and coals could be thrown from the rotary cutter to areas of vegetation that might ignite. Tire damage can occur when driving over hot material. Oil and grease on the tractor and rotary cutter could ignite, resulting in equipment destruction. Carry a fire extinguisher on the tractor at all times to extinguish possible fires encountered. Do not operate the rotary cutter on a tractor with an underframe exhaust.
- When you get to the end of a pass, slightly raise the rotary cutter (2-4") before turning. Never raise the rotary cutter entirely while the blades are turning. If the rotary cutter must be raised higher than 12" from ground level, disengage the tractor PTO and wait for all blade rotation to come to a complete stop before proceeding to raise the rotary cutter.
- Large, dense, or wet vegetation may need to be cut in two or more passes to achieve a uniform cut. In such conditions, raise the cutting height to 12" or more on the first pass. Then lower the rotary cutter to the desired height and mow the vegetation a second time. If possible, select a cutting direction that is at a 90 degree angle to the first pass to reduce streaking for a more uniform cut.
- Stay alert and watch for trees, low hanging limbs, power lines, and other overhead obstacles and solid ground objects while you are operating. Use care to avoid hitting these items.
- Avoid cutting in reverse. Instead, disengage the PTO, wait for the blades to stop, and raise the deck. Back up into the area to be cut. Lower the deck, engage the PTO, and cut forward.

6.12 Optional Chain Shielding

Titan Implement strongly recommends installing the optional chain shielding on all rotary cutters.

Full chain shielding must be installed when operating in populated areas or other areas where thrown objects could injure people or damage property.

If the rotary cutter is not equipped with full chain shielding, operation must be stopped when anyone comes within 300 feet.

The shielding is designed to reduce the risk of thrown objects. The rotary cutter deck and protective devices cannot prevent all objects from escaping the blade enclosure in every mowing condition. It is possible for objects to ricochet and escape, traveling as much as 300 feet.

Inspect chain shielding each day of operation and replace any broken or missing chains, as required.

6.13 Right of Way (Roadway) Mowing

Use double chain guards for highway, right-of-way, parks, greenbelt mowing, or all other mowing where human dwellings, vehicles, or livestock could be within 300 feet of the cutter.

No shielding is 100% effective in preventing thrown objects. To reduce the possibility of injury:

1. Maintain rotary cutter shielding in good operational condition.
2. Inspect the condition of the thrown object guards, cutter side skirts, and skid shoes daily: Replace or repair worn or damaged guards.
3. Inspect the condition of the blades and blade bolts daily. Replace any cracked, worn, bent or damaged blades. Always replace blade bolts and lockwashers when replacing blades. Make sure the blade bolts are properly tightened.
4. Raise cutting height to 6" minimum.
5. Never allow blades to contact solid objects like rocks, posts, wire, curbs, guardrails, or the ground while mowing.

Rotary cutters can throw objects 300 feet or more under adverse conditions.

To avoid serious injury or death from thrown objects, inspect the area thoroughly for potential thrown objects and remove them before cutting.

Remove debris, rocks, wire, cable, metal objects, and other foreign material from area.

Wire, cable, rope, chains, and metal objects can be thrown or swung outside the deck with great velocity.

Mark the location of objects that cannot be removed.

Stop mowing if passersby are within 300 feet unless:

1. All thrown object shielding including front and rear deflectors, chain guards, steel guards, bands, side skirts, and skid shoes are in place and in good condition when mowing.
2. Mower sections or wings are adjusted to be close and parallel to ground without exposing blades.
3. Mowing area has been inspected and foreign materials and debris have been removed.
4. Passersby are inside an enclosed vehicle.

7. Transporting

7.1 Transporting Safety (Road)

WARNING



The following safety instructions can and will result in serious injury and possibly even death if they are not understood and followed.

 **Tractor Owner/Operator Manual**
Always refer to the tractor owner's manual to determine its compatibility and maximum safety.



 **Operating the Tractor**
Before attaching the rotary cutter to the tractor, be familiar with its controls and how to stop it quickly in the event of an emergency. Read and understand this manual and the one provided with your tractor before transporting the rotary cutter.

 **Fall and Crush Hazard**
Do not allow riders on the rotary cutter or tractor.

 **Maximum Transporting Speed**
Do not exceed 20 MPH when transporting the rotary cutter. Slow down for corners and rough terrain.

  **Visibility**
Clean reflectors, SMV or SIS sign, and lights before towing. Make sure all the lights and reflectors required by highway and transport authorities are in place and can be seen clearly by all overtaking and oncoming traffic.

 **Regulations**
Make sure all local, state, and federal regulations, regarding the transport of equipment on public roads and highways, are met. Check with the local authorities regarding transporting the rotary cutter on public roads. Obey all applicable laws and regulations.

  **Rollover Protection**
The tractor should be equipped with a Roll Over Protective Structure (ROPS) and a seat belt.

SAFETY INSTRUCTIONS

The following safety instructions are provided to help prevent injury or limit equipment damage.

 **Drive Safely**
Be a safe and courteous driver. Anticipate what other drivers will do and drive accordingly.

 **Allow Extra Distance**
Apply brakes early. Leave extra distance between your vehicle and the one(s) ahead to provide adequate stopping space. Extra distance will be required to stop the vehicle.

 **Clear Vision**
Remove all objects from the area that would prevent clear vision of the complete work area or would present an obstacle when moving the rotary cutter.

 **Hitch Attachment**
Be sure the rotary cutter is securely attached to the tractor and in good operating condition before using.

 **Working Taillights**
Make sure lights on the tractor are working properly.

 **Additional Lighting**
For rotary cutters without lights, install additional lights on the rear of the tractor to safeguard against rear-end collisions. Daybreak and dusk are particularly dangerous and rear pilot vehicles are recommended. Rotary cutters without lights should be transported on public roads only during daylight hours.

 **Hazard Flashers**
Use hazard flashers on the tractor when transporting unless prohibited by law.

 **Right-of-Way**
When travelling below the posted speed limit, keep to the right and yield the right-of-way to allow faster traffic to pass.

5. Before transporting, make sure the PTO is disengaged and all blade movement has stopped.
6. Do not travel faster than 20 mph when transporting. Only transport using a tractor. Always slow down for rough terrain and when cornering.

8. Storage

8.1 Storage Safety

At the end of the season, the rotary cutter should be thoroughly inspected and prepared for storage. Repair or replace any worn or damaged components to prevent unnecessary downtime at the beginning of the next season.

CAUTION



Personal Injury Hazard

Store the rotary cutter in an area away from human activity. To prevent the possibility of serious injury, do not permit children to play on or around the stored rotary cutter.



Crush Hazard

Always set the rotary cutter on safety stands or on blocks for storage.

NOTICE

To prevent damage to the rotary cutter, store it in a dry, level area.

8.2 Placing In Storage

1. Remove all entangled vegetation.
2. Thoroughly wash the rotary cutter with a pressure washer or water hose to remove all clippings, dirt, mud, or debris.
3. Select an area that is dry, level, and free of debris (inside a building is ideal). Move the rotary cutter to its storage area.
4. Raise the rotary cutter with the 3-point hitch and place blocks under the side skirts. Lower the rotary cutter onto the blocks.
5. Disconnect the cutter drive line and secure it up off the ground.
6. Disconnect the rotary cutter from the 3-point hitch and drive the tractor away from the rotary cutter. Do not leave the tractor attached to the rotary cutter.
7. Lubricate all grease points. Make sure all grease cavities have been filled with grease to remove any water residue from washing.
8. Touch up all paint nicks and scratches to prevent rusting.

8.3 Removing From Storage

When removing the rotary cutter from storage, follow this procedure:

1. Attach the rotary cutter to the tractor 3-point hitch.
2. Raise the rotary cutter up off the blocks.
3. Before placing the rotary cutter back into service, replace any worn or defective parts and perform the Pre-Operation Checklist.

9. Service and Maintenance

9.1 Maintenance Safety

WARNING

Failure to comply with the following safety instructions can and will result in serious injury and possibly even death.



Personal Protection Equipment

Wear close fitting and belted clothing to avoid getting caught in moving parts. Wear personal protection equipment (PPE), which may include hard hat, safety glasses, safety shoes, gloves, etc. , appropriate for the work site and working conditions.



Disconnect Driveline

To prevent injury due to possible unexpected movement, disconnect the driveline from the tractor PTO before performing any maintenance procedure.



Damaged Parts Hazard

Do not use the rotary cutter if any parts are damaged. If the rotary cutter is believed to have a defect which could cause it to work improperly, immediately stop using it and remedy the problem before continuing.



No Unauthorized Modifications

Do not modify the rotary cutter or safety devices. Do not weld on the unit. Unauthorized modifications may impair its function and safety and will void the warranty.

If the rotary cutter has been altered in any way from the original design, the manufacturer does not accept any liability for injury or warranty.



Crush Hazard

Always set the rotary cutter on safety stands or on the ground when performing maintenance.



Good Working Condition

Keep all parts in good condition and properly installed. Fix damage immediately. Replace worn or broken parts.



Replacement Parts

If replacement parts are necessary, genuine factory replacement parts must be used to restore the unit to its original specifications. The manufacturer will not accept responsibility for damages as a result of the use of unapproved parts.

WARNING



Safety Shields and Devices

When completing a maintenance or service function, make sure all safety shields and devices are installed before placing the rotary cutter in service.

SAFETY INSTRUCTIONS

The following safety instructions are provided to help prevent injury or limit equipment damage.



Safety Equipment

A fire extinguisher and first aid kit should be readily accessible while performing maintenance on this equipment.



Clean Work Area

Do not leave tools lying around the work area. Follow good shop practices. Keep service area clean and dry. Be sure electrical outlets and tools are properly grounded. Use adequate light.



Use the Right Tools

Use the correct tools, jacks, hoists, or other tools that have the capacity for the job.



Proper Support

Use certified safety stands rated to support the load when working beneath the rotary cutter, or performing repairs, service, or maintenance.

Before working underneath the rotary cutter, place it on a minimum of four jack stands, with a load rating of at least 1000 lbs. each.

Do not position the jack stands under wheels, axles, or wheel supports, as they may rotate and cause the rotary cutter to fall.

Make sure the jack stands are stable and the rotary cutter deck is approximately level. Test the stability of the rotary cutter before working underneath.

If the rotary cutter is attached to the tractor, set the brakes, remove the key, chock the tractor wheels, and block the rotary cutter before working underneath.

Tighten the lower 3-point arm anti-sway mechanism to prevent side-to-side movement.

9.2 Greasing

See the diagram for the location of all grease zerks.



Grease all zerks every fifty hours of operation. Use an SAE multipurpose high-temperature grease with extreme pressure (EP) performance. Also acceptable is an SAE multipurpose lithium base grease.

1. Always use a handheld grease gun for all greasing.
2. Wipe grease zerks with a clean cloth before greasing to avoid injecting dirt and grit.
3. Apply grease until new grease can be seen coming out of the joint.
4. Do not let excess grease collect on or around parts, particularly when operating in sandy areas.
5. Replace and repair broken grease zerks immediately.
6. If any grease zerk will not take grease, remove and clean it thoroughly. Also clean the lubricant passageway. Replace the zerk if necessary.

9.3 Gearbox Lubrication

The gearboxes are filled at the factory and should require no maintenance. If there is evidence of leakage, the grease level should be checked. If required, grease should be added until it comes to the proper level. Recommended lubricant is EP-0 Grease.

Note: Make sure the rotary cutter is level when checking the oil in the gearbox.

Note: Overfilling the gearbox will cause pressure to build up and cause the seals to leak.

9.4 Driveline Lubrication

Lubricate the driveline slip joint every fifty operating hours.

1. Lower the rotary cutter to the ground, disconnect the driveline from the tractor PTO shaft, and slide the halves apart but do not disconnect from each other.
2. Apply a bead of grease completely around male half where it meets female half. Slide drive halves over each other several times to distribute grease.

9.5 Blade Servicing

Inspect blades before each use to determine that they are properly installed and in good condition. If any blade is bent, excessively nicked, worn, or has any other damage, replace both blades. Small nicks can be ground out when sharpening.

Manually wiggle the blade carrier to check for any looseness. Recheck torque every fifty hours. Retighten any loose parts.

9.5.1 Blade Removal

To remove the blades for sharpening or replacement, remove the nut and lockwasher from the blade bolt through the inspection hole in the deck of the mower near the gearbox.



9.5.2 Blade Installation

When installing blades, be sure to check the blade bolt pivot diameter for wear. Replace the bolt if worn more than 1/4 inch at any point. Tighten nut to 600 ft. lbs.

Always use a new lockwasher and nut when replacing the blade bolt.

Make sure blades are installed with the cutting edge in the direction of rotation. The left spindle rotates counterclockwise as viewed from above the deck. The right spindle rotates clockwise as viewed from above the deck.

9.5.3 Blade Sharpening

CAUTION



Sharp Object Hazard

The grinder may catch on the blade during sharpening, propelling it forcefully. To prevent the possibility of serious injury, make sure blades are secured against movement while sharpening.

When sharpening blades, always sharpen both blades at the same time and grind the same amount on each blade to maintain balance. Unbalanced blades will cause excessive vibration, which can damage gearbox bearings. Vibration may also cause structural cracks to the rotary cutter. Follow the original sharpening pattern. Do not sharpen blades to a razor edge, leave a 1/16" blunt edge. Do not sharpen the back side of the blade. Do not heat and pound out the edge.

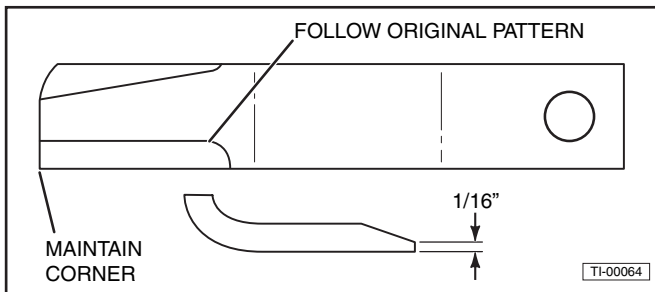

Replace the blades when worn more than 1/2" from the original edge. Always replace blades in pairs.

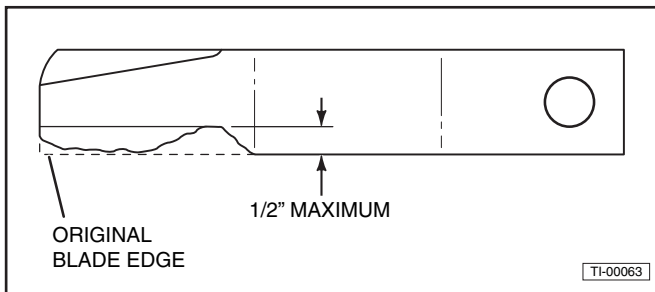

9.6 Blade Carrier Removal

1. Remove the cotter pin and loosen the castle nut on the gearbox shaft. Do not remove the nut until the blade carrier is loosened.
2. Use a suitable two jaw gear puller to pull the carrier off the tapered gearbox shaft.
3. If a gear puller is not available, insert a bar through the blade bolt access the hole with the end against the blade carrier. Strike the opposite end of the bar sharply. Rotate the blade carrier 180 degrees and repeat until the carrier breaks loose.
4. Remove the castle nut and the blade carrier.

9.7 Blade Carrier Installation

1. Clean the splines on both the blade carrier and the output shaft.
2. Position the carrier on the gearbox output shaft with the blade bolts located at 90° to the other blade carrier and install the castle nut. Tighten the nut to a minimum 450 ft. lbs.

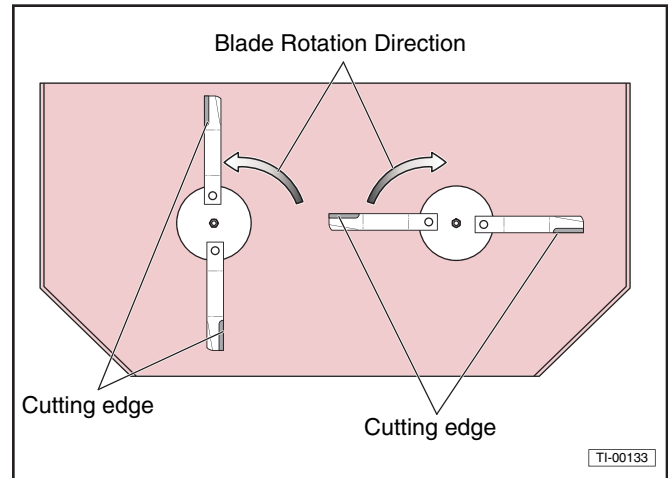

Note: The blade carriers on dual spindle rotary cutters must be "timed" to prevent blade interference. Make sure to install the blade carrier with the blade bolts located at 90° to the other blade carrier.

WARNING



Projectile Hazard

Blade interference can cause blade failure and possible serious injury or death from thrown blades. Make sure to install each blade carrier with the blade bolts located at 90° to the other blade carrier.

3. Strike the carrier near the hub several times with a heavy hammer to seat the hub. Use care not to strike the nut or the end of the shaft.
4. Retighten the nut to 700 ft. lbs.
5. Install the cotter pin and spread the tangs.

9.8 Slip Clutch Operational Check

The slip clutch serves as overall protection for the tractor, driveline, and gearboxes. Even though new clutch assemblies are "run-in" and checked for torque prior to shipment, re-adjustment may be advisable if the clutch has been exposed to weather for an extended period of time. The clutch facing and plates should be inspected for rust and/or corrosion. After the rotary cutter has been stored for thirty days or more, perform the following check:

1. Make a trial run in the heaviest operating conditions expected. If the clutch slips noticeably, tighten the eight adjusting bolts no more than 1/2 turn between trial runs until the clutch slippage is reduced.
2. Scribe a mark across the clutch facing. When subjected to shock loads, a separation of the marks will assure that the clutch setting is correct.

Note: Check the clutch periodically during the first hour of operation for excessive heat build-up due to unexpected slippage.

If the clutch is being rebuilt (new facing and/or plates), it is necessary to “run-in” these parts prior to final adjustment. The plates should be thoroughly cleaned and free of foreign material, as well as being checked for warping with a straight edge. Warped plates cannot be adjusted properly and will not hold. To accomplish the “run-in” after assembly, follow this procedure:

1. Tighten all the adjusting bolts evenly until the clutch cannot be slipped by hand.
2. With the blade carrier locked in a stationary position, operate with the PTO at idling speed (approx. 100 RPM), until evidence of heating is noted. **Do not allow the clutch to overheat.**
3. Discontinue operation and **allow the clutch to cool completely.**
4. After the clutch has cooled, tighten all the adjusting bolts evenly and proceed with the regular clutch adjusting procedures as described above.

9.9 Slip Clutch Adjustment

The slip clutch is factory preset to the correct torque for protecting the implement and tractor: Periodic adjustment is recommended. Should adjustment be needed, follow this procedure:

1. Check to be sure all spring lengths are the same. Initial spring length is shown in the chart.

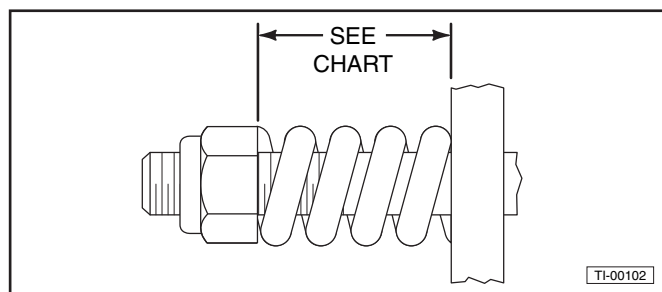

CLUTCH SPRING LENGTH CHART	
EG / COMER	BONDIOLI & PAVESI
1.27" (32.2mm)	1.15" (29.3mm)
1.28" (32.4mm)	1.12" (28.5mm)

2. If necessary, adjust the nut on any spring that is unequal. Adjust all eight spring retaining nuts 1/3 of a turn (two flats on a nut) and check clutch slippage.
3. If further adjustment is necessary, adjust in 1/3 turn increments. Adjust only to provide sufficient torque to prevent slippage under normal conditions. Occasional slippage is normal for drive train protection. If satisfactory results cannot be obtained, consult your authorized dealer.

NOTICE

Do not overtighten and cause the spring to become solid, as this will cause shaft failure.

9.10 Bolt Torque Requirements

It is extremely important to apply and maintain proper torque on all bolts. Use a torque wrench to assure the proper amount of torque is being applied to the fastener. For proper bolt torque values, refer to “11.1 Bolt Torque” on page 47.

Start all bolts or nuts by hand to prevent cross threading.

9.11 Welding Repairs



Before performing any type of welding repair to the rotary cutter, contact Titan Implement for approval. Repair welding must be done with care and with procedures that may be beyond the capabilities of the ordinary welder.

⚠ WARNING



Projectile Hazard
Do not attempt to weld on the blades. They are hardened and will crack or otherwise be damaged, causing failure and possible serious injury or death from thrown blades.



Personal Injury Hazard
Repairs or modifications to the rotary cutter can result in serious injury or death should these repairs fail.

NOTICE

Anyone performing a welding repair should be certified in accordance to the American Welding Society (AWS) standards.

9.12 Service Record

The period recommended is based on normal operating conditions. Severe or unusual conditions may require more frequent lubrication or oil changes.

Copy this page to continue record.

Hours and Serviced By																				
Maintenance																				
Before Each Use																				
Make sure blade bolts are tightened to proper torque.																				
Make sure all retainer clips and cotter pins are in place.																				
Inspect the cutting blades for wear and damage.																				
Every 50 Hours																				
Check blade carrier nut torque.																				
Grease all lubrication points.																				
Annually																				
Grease all lubrication points.																				
Make sure all fasteners are properly tightened.																				
Check cutter deck, gearboxes, and driveline for damage.																				
Inspect the cutting blades for wear and damage.																				
Make sure the 3-point hitch pins and retainer clips are in good condition. Do not use homemade or shop-made pins.																				
Make sure the slip clutch is functioning properly.																				
Inspect the hitch A-frame and braces for wear and damage.																				
Wash the rotary cutter.																				

10. Troubleshooting

PROBLEM	CAUSE	SOLUTION
Uneven cut.	Excessive ground speed.	Reduce ground speed.
	Blades worn, dull, or bent.	Replace blades.
	Mower not level side-to-side.	Adjust. Refer to "6.3 Attaching to Tractor" on page 31.
	Improper height adjustment.	Adjust rotary cutter height. Refer to "6.5 Setting the Rotary Cutter" on page 32.
	Low tractor tire pressure on one side.	Adjust tire pressure. (Refer to OEM manual).
	Turning too fast.	Reduce ground speed when turning.
	Tractor tires push grass down.	Adjust your tractor wheel spacing. (Refer to OEM manual).
	Damaged cutter pan.	Repair or replace as necessary.
Uncut material.	Excessive ground speed.	Reduce ground speed.
	RPM too low.	Maintain 540 RPM PTO speed.
Windrowing.	Material heavy and lush.	Raise the front of rotary cutter relative to the rear. Refer to "6.5 Setting the Rotary Cutter" on page 32.
	Excessive ground speed.	Reduce ground speed.
	Conditions too wet.	Wait for conditions to dry. Reduce ground speed.
Grass cut lower in center of swath than at edge.	Height of rotary cutter lower at rear or front.	Adjust rotary cutter height and attitude so that rear and front are within 1/2" of same height.
Streaking conditions in swath.	Blades dull.	Sharpen or replace blades.
	Blades unable to cut that part of grass pressed by path of tractor tires.	Slow ground speed of tractor but maintain 540 RPM PTO speed. Cutting lower will help.
	Conditions too wet for mowing.	Allow grass to dry before mowing.
Material discharges from cutter unevenly; bunches of material along swath.	Material too high and too much material.	Reduce ground speed but maintain 540 RPM at tractor PTO or make two passes over material. Raise rotary cutter for the first pass and lower to desired height for the second and cut at 90° to first pass. Raise rear of rotary cutter high enough to permit material to discharge but not so high as to cause conditions listed above.
	Grass wet.	Allow grass to dry before mowing. Slow ground speed of tractor but keep engine running at full PTO RPM. Cutting lower will help.
	Rear of rotary cutter too low, trapping material under cutter.	Adjust rotary cutter height and attitude.
Rotary cutter will not cut all the time. (Slip clutch drive only)	Slip clutch slipping.	Adjust slip clutch. Refer to "9.9 Slip Clutch Adjustment" on page 42.
	Burnt or damaged clutch facing.	Rework clutch or replace according to OEM manual.
Blade bolts working loose.	Bolts not tightened.	Tighten bolts. Refer to "9.5 Blade Servicing" on page 40.
	Bolt hole elongated or oversized.	Replace blade carrier. Refer to "9.6 Blade Carrier Removal" on page 41.
	Lockwasher broken.	Replace lockwasher. Refer to "9.5 Blade Servicing" on page 40.
Gearbox noisy.	Low lubricant level.	Add grease. Refer to "9.3 Gearbox Lubrication" on page 40.
	Rough gears.	Run in or replace gearbox.
	Worn bearing.	Replace gearbox.

Gearbox leaking.	Damaged oil seal.	Replace seal.
	Bent shaft.	Replace gearbox.
	Oil seal not sealing in the housing.	Replace seal or use a sealant on O.D. of seal.
	Oil level too high.	Drain to proper level.
	Gasket damaged.	Replace gasket.
	Bolts loose.	Tighten bolts.
Gearbox overheating.	Low on lubricant.	Fill to level plug.
	Improper type of lubricant.	Replace with proper lubricant. Refer to "9.3 Gearbox Lubrication" on page 40.
	Excessive trash build-up around gearbox.	Remove trash.
Excessive vibration.	Blades are not free to swing.	Check bushing and blade movement.
	Blades are out of balance.	Check blades for damage or replace blades. Refer to "9.5 Blade Servicing" on page 40.
Unusual noise.	Loose blade bolts or worn bushings.	Tighten bolts, check bushings for wear and change as needed. Refer to "9.5 Blade Servicing" on page 40.
	Bent blade carrier, blades.	Replace blade carrier. Refer to "9.6 Blade Carrier Removal" on page 41.
	Deck bent, causing blades to contact deck.	Straighten deck.
Driveline will not telescope.	Improper lubrication.	Grease driveline. Refer to "9.4 Driveline Lubrication" on page 40.
	Driveline twisted.	Replace driveline. Caution operator not to strike ground with blades.
	Driveline bent.	Driveline too long. Replace and shorten to proper length. Refer to "5.5 Shortening the Driveline" on page 27.
	Shields damaged.	Replace shields.
Driveline twisted.	Overtorqued.	Do not allow blades to contact ground.
	Not maintaining correct PTO speed.	Maintain 540 RPM PTO speed.

11. Specifications

Model	1708	1808	1810
Horsepower Required (Min.)	42	42	52
Hitch	CAT I	CAT I or II	CAT I or II
Cutting Width	94"	94"	117"
Cutting Height	2" to 10"	2" to 10"	2" to 10"
Transport Width	98"	98"	122"
Weight	1250	1250	1480
Cutting Capacity	2"	3"	3"
Deck Thickness	12 Gauge	10 Gauge	7 Gauge
Side Bands	7" Channel	8" Channel	8" Channel
Skid Shoes	Replaceable	Replaceable	Replaceable
PTO Driveshaft	Series 5 with Slip Clutch	Series 5 with Slip Clutch	Series 5 with Slip Clutch
Center Driveshaft	Shock Coupler Protected	Shock Coupler Protected	Shock Coupler Protected
Stump Jumper	5/8" Plate	5/8" Plate	5/8" Plate
Gearbox	125 HP	125 HP	125 HP
Outboard Gearboxes	100 HP	100 HP	100 HP
Wheels	Laminated	Laminated	Laminated
Hub	Greaseable	Greaseable	Greaseable
Quick Hitch Compatible	Yes, CAT I	Yes, CAT II	Yes, CAT II
Gearbox Warranty	5 Year Limited	5 Year Limited	5 Year Limited

Specifications subject to change without notice.

11.1 Bolt Torque

Torque figures indicated in the charts are used for non-greased or non-oiled threads and heads unless otherwise specified. Therefore, do not grease or oil bolts or cap screws unless otherwise specified in this manual. When using locking elements, increase torque values by 5%.

The tables shown below give correct torque values for various bolts and capscrews. Tighten all bolts to the torques specified in the charts unless otherwise noted. Check tightness of bolts periodically, using the bolt torque chart as a guide. Always replace hardware with the same Grade bolt.

11.1.1 Standard Torque Values

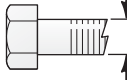
 Bolt Diameter	English Bolt Torque Specifications*					
	Grade 2		Grade 5		Grade 8	
	N-m	ft.lbs.	N-m	ft.lbs.	N-m	ft.lbs.
1/4"	8	6	12	9	17	12
5/16"	13	10	25	19	36	27
3/8"	27	20	45	33	63	45
7/16"	41	30	72	53	100	75
1/2"	61	45	110	80	155	115
9/16"	95	60	155	115	220	165
5/8"	128	95	215	158	305	220
3/4"	225	165	390	290	540	398
7/8"	230	170	570	420	880	650
1"	345	225	850	630	1320	970

⚠ WARNING



EQUIPMENT FAILURE

The torque value for bolts and capscrews are identified by their head markings. Replacing higher "Grade" bolts (Grade 5) with lower Grade bolts will lead to equipment failure and can result in injury or death. Always use replacement bolts with the same Grade markings as the removed bolt.

12. Warranty

TITAN IMPLEMENT LIMITED WARRANTY

TITAN IMPLEMENT, LLC. (the "Manufacturer") warrants, only to the original Purchaser, this equipment will be free from defects in material and workmanship, under normal use and service, for one (1) year from the date of purchase providing this equipment is purchased for individual use only. **Commercial use of this equipment is not covered under any warranty.** This warranty does not apply to any equipment which has been damaged or which has been subjected to change, misuse, negligence, abnormal wear and tear, alterations, tampering, or failure to follow operating instructions. This warranty does not cover any product or parts not manufactured by Titan Implement, LLC.

Titan Implement, LLC rotary cutters have a five (5) year Limited Warranty* on gearbox components provided they have been properly maintained and have not been subjected to abuse or misuse except as limited below.**

***Gearbox warranty limitations:**

- i. Warranty is one (1) year for seals unless seals are damaged from debris wrapped around the input and or output shaft of the gearbox. After one year, seals are considered to be wearing parts, and the replacement is the owner's responsibility.
- ii. Gearboxes that are subject to warranty may be replaced with new or rebuilt gearboxes at the discretion of Titan Implement, LLC.
- iii. **Shearbolts must be approved Grade 2, 1/2" x 3" shearbolts.**

****NOTE: "properly maintained" specifically includes, but is not limited to:**

- i. Running gearboxes with the proper amount of correct lubricant.
- ii. Adjusting slip clutches correctly to provide proper protection for gearbox components and drive line.

Under this warranty, the Manufacturer will repair or replace any part which the Manufacturer determines has failed during the period of the warranty due to defects in material or workmanship. After written approval by the manufacturer, the equipment or defective part must be returned to Titan Implement, LLC.

Warranty coverage and performance is expressly conditioned upon the return of the completed registration form to Titan Implement, LLC, PO Box 649, Decatur, Tennessee 37322.

Titan Implement, LLC reserves the right to make improvements and changes in specifications without notice or obligation to modify previously sold units. The Owner's Manual describes the proper assembly procedures for your implement and furnishes operating and maintenance recommendations to help you obtain long and satisfactory service.

PURCHASER'S EXCLUSIVE REMEDY FOR BREACH OF WARRANTY, OTHER DEFECT, OR CONDUCT GIVING RISE TO LIABILITY SHALL BE THE REPAIR OR REPLACEMENT OF THE PRODUCT SOLD, AND THE MANUFACTURER UNDER NO CIRCUMSTANCES SHALL BE LIABLE FOR ECONOMIC LOSS OR INCIDENTAL OR CONSEQUENTIAL DAMAGES. THE MANUFACTURER DISCLAIMS ALL IMPLIED WARRANTIES, INCLUDING THE WARRANTY OF MERCHANTABILITY AND FITNESS FOR PURPOSE.

Purchaser and Titan Implement, LLC hereby (a) submit to the non-exclusive jurisdiction of the courts of competent jurisdiction in Meigs County, Tennessee, and the United State District Court for the Eastern District of Tennessee for resolution of any dispute concerning this Limited Warranty or the rights or obligations of Purchaser and/or Titan Implement, LLC; (b) agree that any litigation commenced in Tennessee in connection with this Limited Warranty shall be venued in either the Meigs County, Tennessee District Court, or the United States District Court, Eastern District of Tennessee, Southern Division, and (c) waive any objection it may have as to any such action or proceeding brought in such court that such court is an inconvenient forum. Nothing herein shall limit the right of Purchaser or Titan Implement, LLC (or the right of any permitted successor or assign of either) to bring proceedings against the other in the courts of any other jurisdiction wherein any assets of such other party may be located.

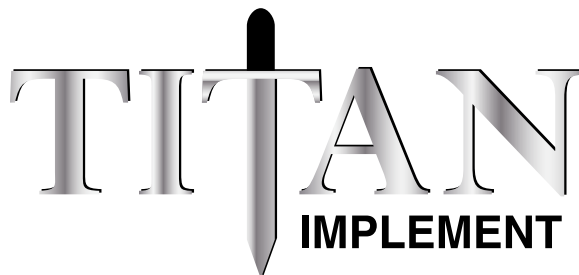

WARRANTY REGISTRATION FORM ROTARY CUTTERS

THIS REGISTRATION FORM MUST BE ON FILE WITH TITAN IMPLEMENT, LLC.
WITHIN **30 DAYS** OF DELIVERY TO PURCHASER, OR WARRANTY CLAIM WILL NOT BE HONORED.

PLEASE RETURN COMPLETED FORM BY E-MAIL, FAX, OR MAIL:

E-MAIL: info@titanimplement.com

FAX: (423) 334-0023

MAIL: PO BOX 649, DECATUR, TN 37322

MODEL: _____ SERIAL #: _____ DELIVERY DATE: _____

TRACTOR MAKE & MODEL BEING USED WITH ABOVE UNIT: _____

PURCHASER'S NAME: _____

ADDRESS: _____

CITY: _____ STATE: _____ ZIP: _____

SELLING DEALER'S NAME: _____

CITY: _____ STATE: _____ ZIP: _____

I have read all warranties and agree with these conditions. I agree to read and follow all safety instructions outlined in this manual before operating this rotary cutter.

Purchaser's signature: _____

Cut Here to Remove Page or Make Copies of This Page

13. Parts

Replacement parts are available from your authorized Dealer Parts Department or from Titan Implement.

The following pages contain a list of serviceable parts for the Titan Implement Dual Spindle Lift Type Rotary Cutters.

13.1 Hitch Assembly

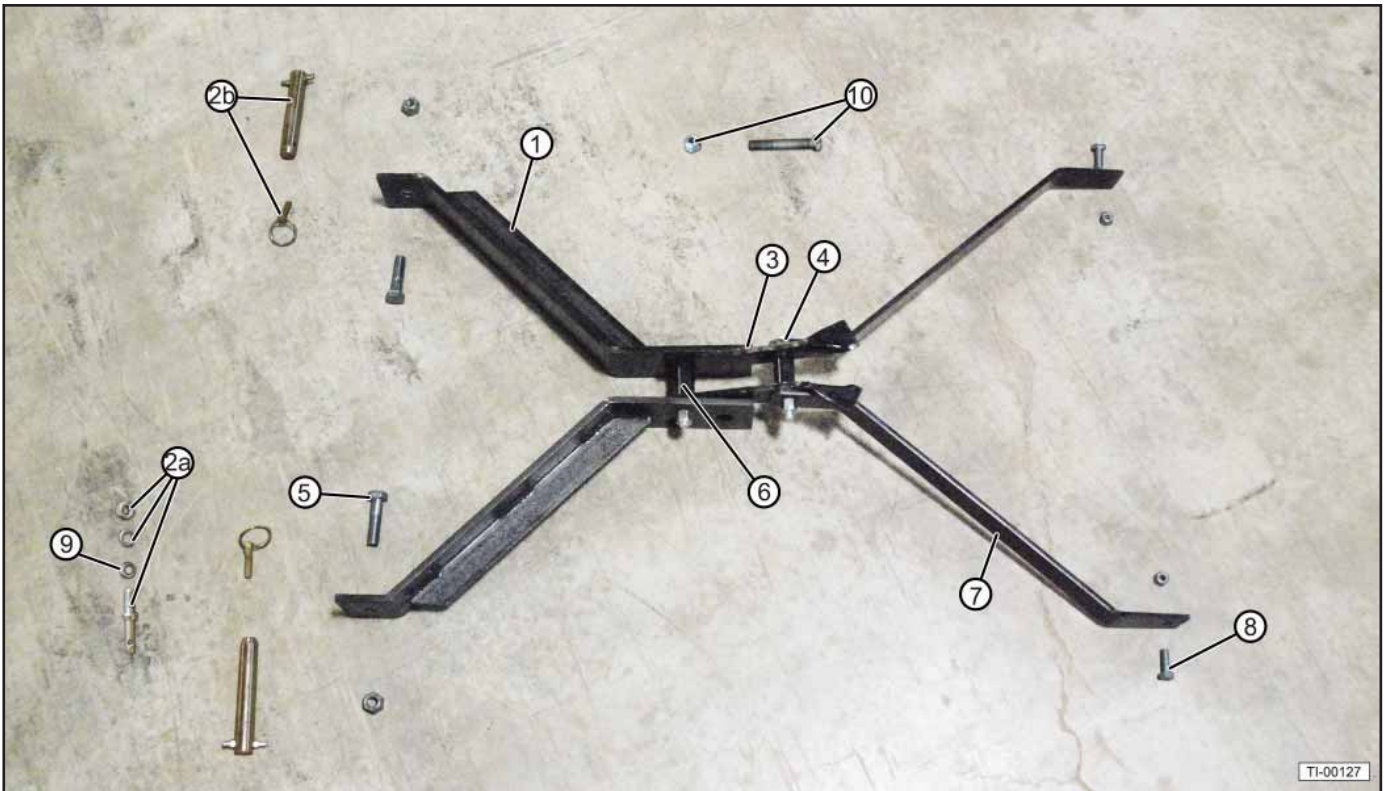

Item	Part Number	Description	Qty.
1	120004	A-Frame, Left or Right Side, 3-Hole Top (1708)	2
	150032	A-Frame, Left or Right Side, Heavy Duty	
2a	110032	Lift Pin Kit, CAT I (1708)	2
2b	150033	Lift Pin Kit, CAT II	
3	120006	Knuckle, Wing Style	1
4	140004	A-Frame Knuckle Bolt & Locknut Kit, 5/8-11 x 5"	2
5	160000	A-Frame Bottom Bolt & Locknut Kit, 3/4-10 x 3"	2
6	140005	A-Frame Spacer, 2-1/4"	2
7	150036	Back Brace, 3/8 x 2 x 29-1/2"	2
	170000	Back Brace, 3/8 x 2 x 26-1/2" (1708)	
8	120009	Back Brace Rear Bolt & Locknut Kit, 1/2-13 x 1-1/2	2
9	150034	Lift Pin Bushing (1708)	2
10	140018	A-Frame Knuckle Bolt & Locknut Kit, 3/4-10 x 5" (1708)	1

13.2 Deck Assembly

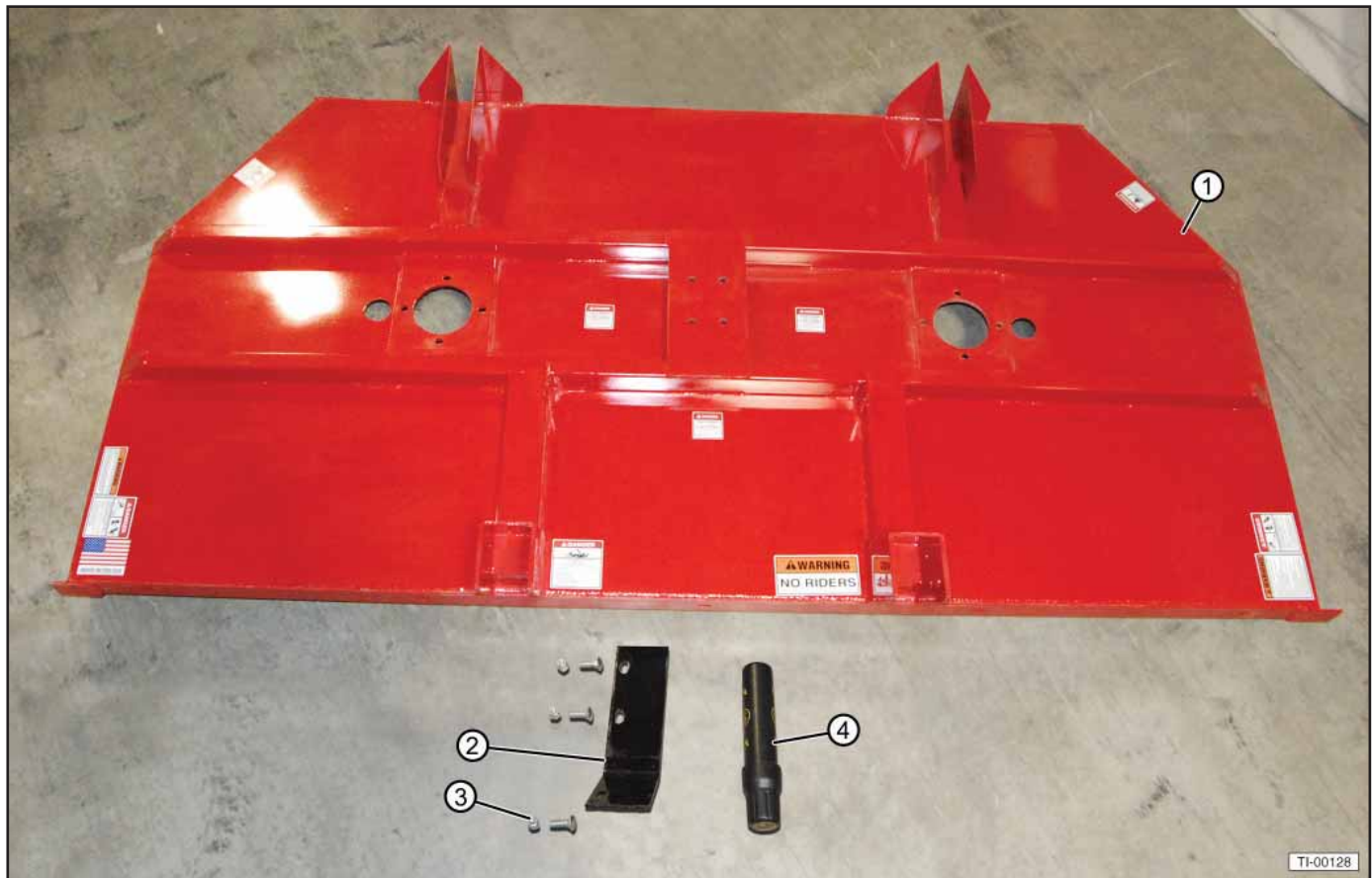

Item	Part Number	Description	Qty.
1	170001	8' Deck Only with Decals (1708) Red	1
	170002	8' Deck Only with Decals (1708) Green	
	170003	8' Deck Only with Decals (1708) Orange	
	170004	8' Deck Only with Decals (1708) Yellow	
	170005	8' Deck Only with Decals (1708) Blue	
	170006	8' Deck Only with Decals (1708) Grey	
1	180009	8' Deck Only with Decals (1808) Red	1
	180010	8' Deck Only with Decals (1808) Green	
	180011	8' Deck Only with Decals (1808) Orange	
	180012	8' Deck Only with Decals (1808) Yellow	
	180013	8' Deck Only with Decals (1808) Blue	
	180014	8' Deck Only with Decals (1808) Grey	

Item	Part Number	Description	Qty.
1	180015	10' Deck Only with Decals (1810) Red	1
	180016	10' Deck Only with Decals (1810) Green	
	180017	10' Deck Only with Decals (1810) Orange	
	180018	10' Deck Only with Decals (1810) Yellow	
	180019	10' Deck Only with Decals (1810) Blue	
	180020	10' Deck Only with Decals (1810) Grey	
2	120010	Skid Shoes (Sold in pairs only)	1
3	120011	Skid Shoe Bolt Kit, 1/2-13 x 1-1/2" Carriage Bolt & Locknut (Six Bolts per kit)	1
4	110034	Document Holder with Screws	1

13.3 Tailwheel Assembly

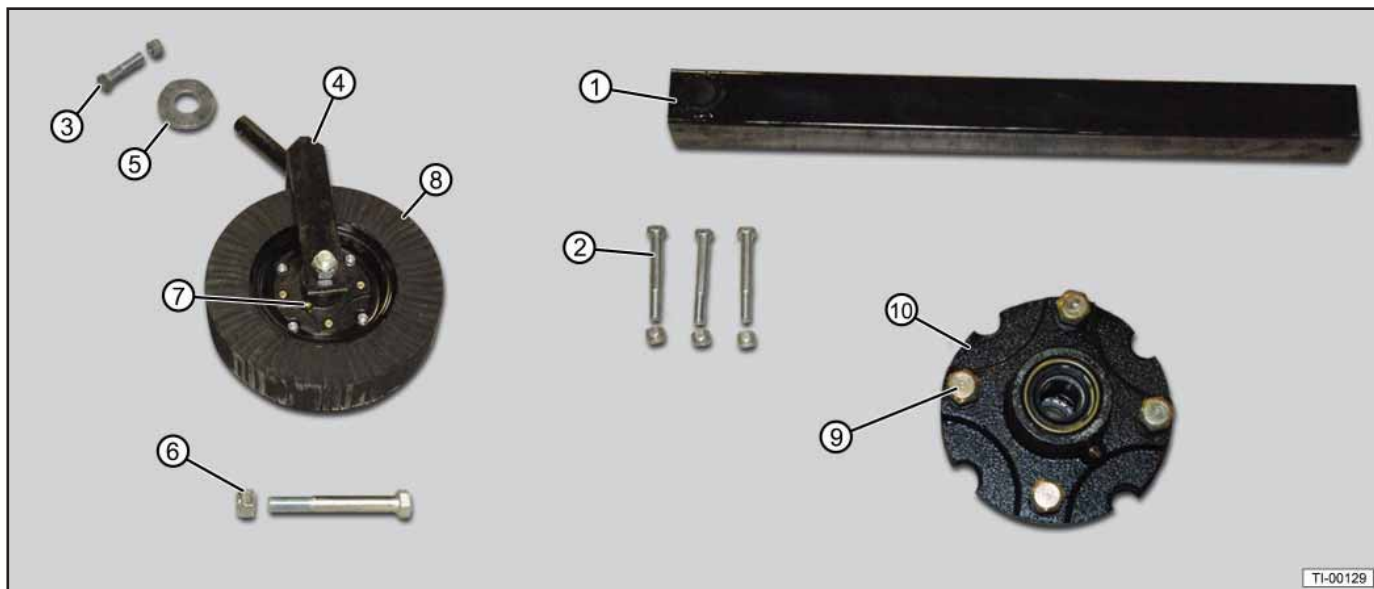

Item	Part Number	Description	Qty.
1	120002	Tailwheel Tube	2
2	120003	Tailwheel Tube Bolt & Locknut Kit, 1/2-13 x 4-1/2"	6
3	110017	Tailwheel Fork Bolt & Locknut Kit, 1/2-13 x 2"	2
4	110018	Tailwheel Fork	2
5	110019	Tailwheel Tube Flat Washer	2
6	150030	Axle Bolt & Locknut Kit, 1-8 x 8"	2
7	110021	Zerk Fitting	2
8	110022	Laminated Wheel	2
9	110023	Wheel Bolt, Lockwasher & Locknut Kit, 5/16-18 x 3/4"	8
10	150031	Wheel Hub, Heavy Duty	2

13.4 Driveline Assembly



Item	Part Number	Description	Qty.
1	180008	Driveline, Series 6, (120H), Slip Clutch, Heavy Duty	1

13.5 Driveline Detail

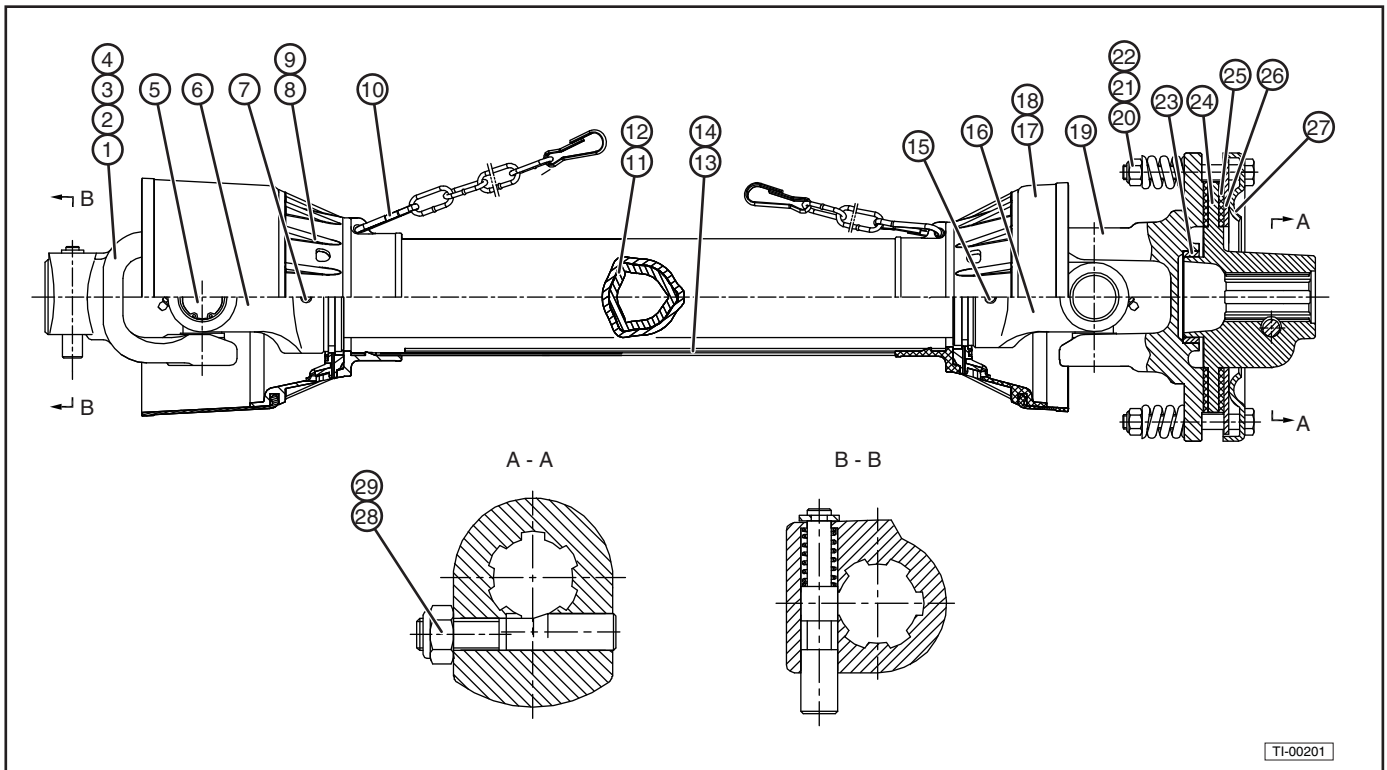

TI-00201

Item	Part Number	Description
1	113-120H-1	Splined Yoke Push Pin
2	113-120H-2	Push Pin
3	113-120H-3	Push Pin Spring
4	113-120H-4	Push Pin Circlip
5	113-120H-5	Universal Joint
6	113-120H-6	Outer Triangular Tube Yoke
7	113-120H-7	Elastic Cylindrical Pin
8	113-120H-8	Outer Tube Cone
9	113-120H-9	Outer Tube Plastic Bearing
10	113-120H-10	Safety Chains
11	113-120H-11-L539	Outer Triangular Tube
12	113-120H-12-L514	Inner Triangular Tube
13	113-120H-13-L455	Outer Plastic Guard
14	113-120H-13-L420	Inner Plastic Guard
15	113-120H-15	Elastic Cylindrical Pin

Item	Part Number	Description
16	113-120H-16	Inner Triangular Tube Yoke
17	113-120H-17	Cone for Inner Tube with Friction Torque Limiter Cone
18	113-120H-18	Inner Tube Plastic Bearing
19	113-120H-19	Flanged Yoke
20	113-120H-20	Hexagon Bolt
21	113-120H-21	Spring
22	113-120H-22	Hexagon Non-metallic Clamping Nut
23	113-120H-23	Bushing
24	113-120H-24	Hub
25	113-120H-25	Friction Lining
26	113-120H-26	Internal Disc
27	113-120H-27	Pressure Plate
28	113-120H-1	Eccentric Pin
29	113-120H-1	Hexagon Non-metallic Clamping Nut

13.6 Cutter Drive System

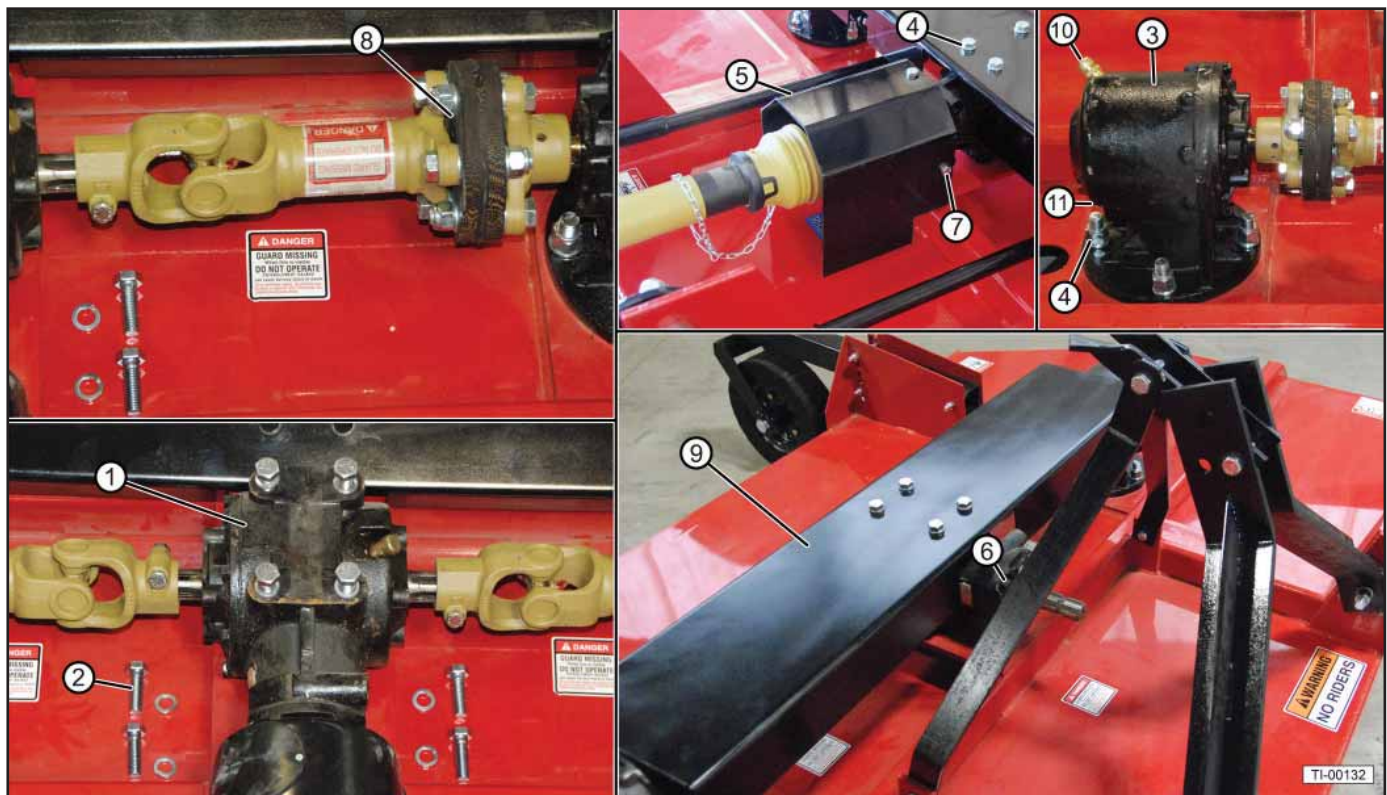

Item	Part Number	Description	Qty.
1	180000	Gearbox, Center Tee	1
2	180001	Center Tee Gearbox Bolt, Lockwasher & Locknut Kit, 5/8-11 x 1-1/4"	4
3	130000	Gearbox, Slip Clutch, 100 HP	2
4	110068	Gearbox Shield Bolt, Lockwasher & Locknut Kit, 1/2-13 x 1-1/2"	12
5	150028	Driveline Shield - Slip Clutch - Metal	1
6	110006	Driveline Shield Backplate Bolts & Washers Kit, 5/16-18 x 1/2" (4 each)	1
7	150027	Driveline Shield Bolt & Lockwasher Kit, 1/2-13 x 1-1/2"	3
8	180002	Shock Coupler, 8'	2
	180003	Shock Coupler, 10'	
9	180004	Center Gearbox Shield, 8'	1
	180005	Center Gearbox Shield, 10'	
10	110008	Gearbox Vent Plug	1
11	110009	Gearbox Drain Plug	1

13.7 Center Tee Gearbox Detail

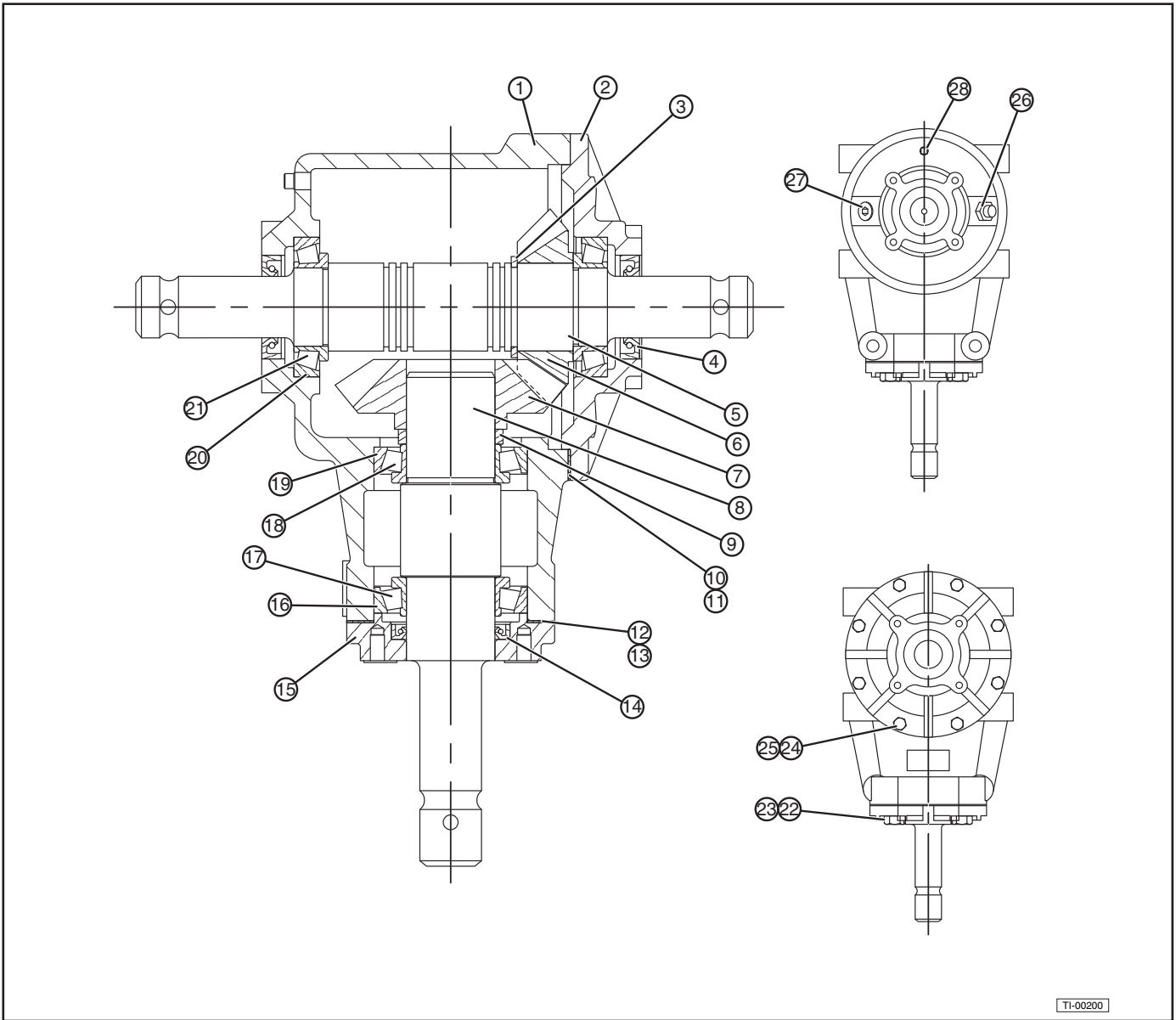

TI-00200

Item	Part Number	Description
1	RW-RO911	Housing
2	RW-RO913	Output Cap
3	RW-404	Retaining Ring
4	RW-204	Seal
5	RW-RO923	Shaft - Output
6	RW-RO924	Gear - Output
7	RW-RO922	Gear - Input
8	RW-RO921	Shaft - Input
9	RW-RO951	Spacer
10	RW-RO541	Gasket
11	RW-RO542	Gasket
12	RW-RO941	Gasket
13	RW-RO942	Gasket
14	RW-203	Seal
15	RW-RO912	Input Cap

Item	Part Number	Description
16	RW-103	Bearing Cup
17	RW-104	Bearing Cone
18	RW-106	Bearing Cone
19	RW-105	Bearing Cup
20	RW-107	Bearing Cup
21	RW-108	Bearing Cone
22	RW-303	Screw
23	RW-304	Washer
24	RW-301	Screw
25	RW-302	Washer
26	RW-502	Plug - Pressure Relief
27	RW-504	Pipe Plug - Inner, 6 Face
28	RW-503	Pipe Plug - Square Head
29	RW-RO952	Tag

13.8 Outboard Gearbox Detail

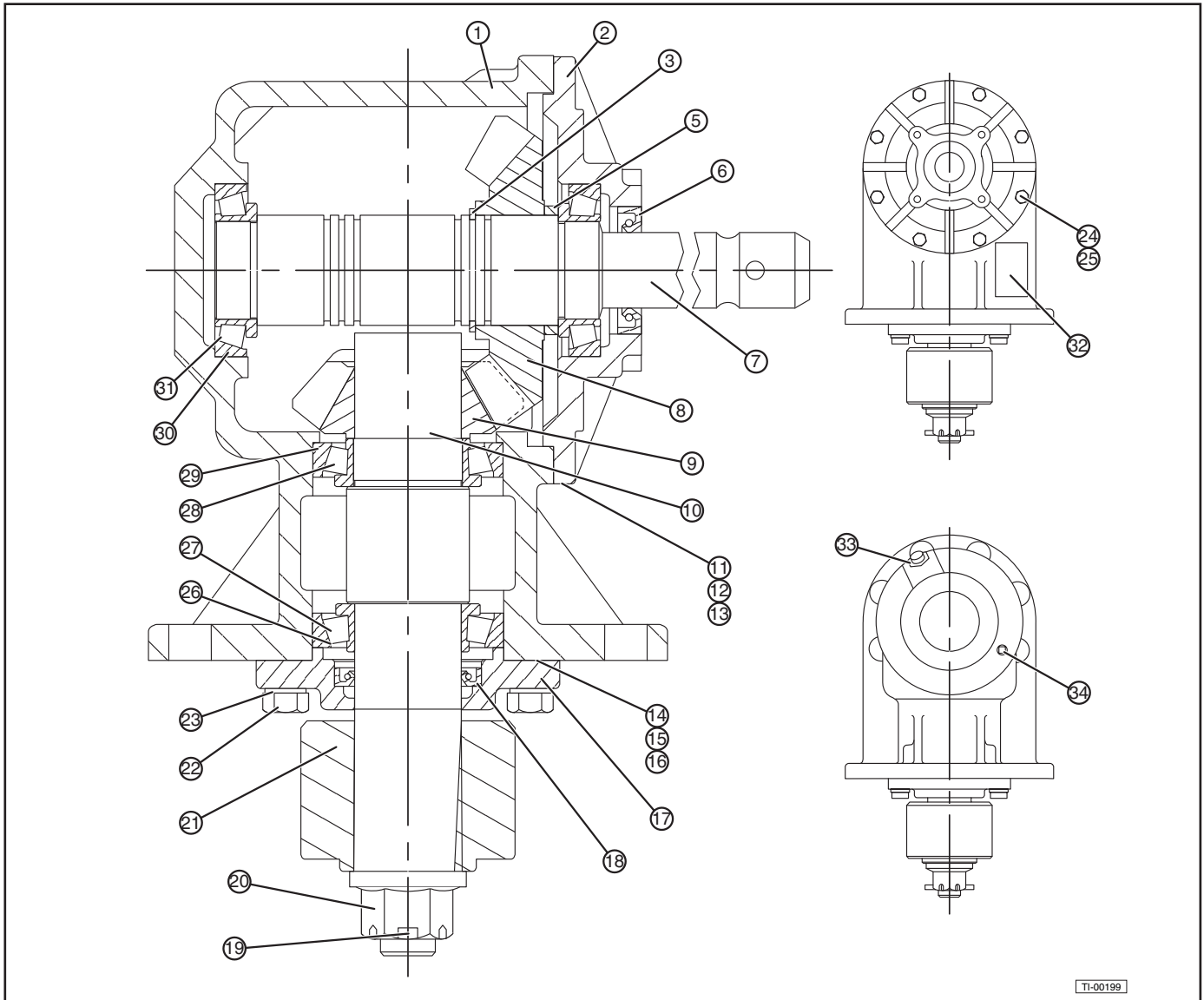

Item	Part Number	Description
1	RW-RO511	Housing
2	RW-RO512	Input Cap
3	RW-404	Retaining Ring
4	—	—
5	RW-RO551	Spacer
6	RW-204	Seal
7	RW-RO621	Shaft - Input
8	RW-RO522	Gear - Input
9	RW-RO524	Gear - Output
10	RW-RO523	Shaft - Output
11	RW-RO541	Gasket
12	RW-RO542	Gasket
13	RW-RO543	Gasket
14	RW-RO544	Gasket
15	RW-RO545	Gasket
16	RW-RO546	Gasket
17	RW-RO913	Output Cap

Item	Part Number	Description
18	RW-203	Seal
19	RW-501	Cotter Pin
20	RW-RO132	Lock Nut
21	RW-RO431	Blade Hub
22	RW-303	Screw
23	RW-304	Washer
24	RW-301	Screw
25	RW-302	Washer
26	RW-103	Bearing Cup
27	RW-104	Bearing Cone
28	RW-106	Bearing Cone
29	RW-105	Bearing Cup
30	RW-107	Bearing Cup
31	RW-108	Bearing Cone
32	RW-RO952	Tag
33	RW-502	Plug - Pressure Relief
34	RW-503	Pipe Plug - Square Head

13.9 Blade Assembly



Item	Part Number	Description	Qty.
1	180007	Blade Carrier, 5/8" x 19-1/2" Flat Type (1708, 1808)	1
2	110011	Blade Carrier, 5/8 x 17" Flat Type (1810)	1
3	110012	Blade Bolt, Washer, Nut Kit, 1-1/8"*	1
4	110013	Blade Carrier Retainer Kit (1" Fine Thread Nut, 1/8" Cotter Pin)	1
5	T-48	Cutter Blades (8')*	1
6	T-48R	Cutter Blades (8') (Reverse)*	1
7	T-60	Cutter Blades (10')*	1
8	T-60R	Cutter Blades (10') (Reverse)*	1

* Sold in pairs only

13.10 Optional Chain Guard



Item	Part Number	Description	Qty.
1	CG-1708	Front & Rear Chain Guard Kit, 8'	1
	CG-1810	Front & Rear Chain Guard Kit, 10'	

TITAN IMPLEMENT, LLC.
P.O. BOX 649
232 INDUSTRIAL LN.
DECATUR, TENNESSEE 37322
PHONE: (423) 334-0012 • FAX: (423) 334-0023
WEB: www.titanimplement.com

Member of

